

Handling Instructions - 2D Gradient Generator Fluidic 1166



Create a 2D gradient on a microfluidic chip

In life science, tight control of the chemical environment is the basis for many experiments. A high spatial and timed resolution is key to successful experiments relying on gradients.

For this reason, we introduce the 2D Gradient Generator Fluidic 1166. It enables you to create gradients with up to six different fluids while at the same time allowing high control of flow and diffusion rates.

For example, it is the perfect tool to investigate the effect of a continuum of concentrations of an analyte or drug on your cells of interest.

Chip description

The 2D Gradient Generator Fluidic 1166 has six inlets, divided into two groups. Each group is connected through serpentine channels which create gradients dependent on the flow rate. The serpentine channels lead into the gradient chamber. Bacteria or other cells of interest can be seeded in this chamber. All inlets and the outlet possess Mini Luer format.

Key features of the 2D Gradient Generator chip are:

- Slide format: 75.5 x 25.5 mm²
- Six inlets and one outlet
- Channel width of mixing serpentine: 80 μm
- Dimension of chamber: 8 x 8 mm²
- Chamber depth: 100 μm

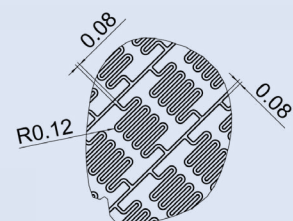
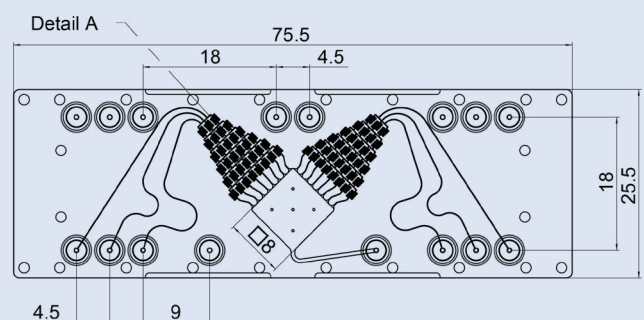

Handling Instructions Fluidic 1166

Necessary equipment

- 2D Gradient generator chip Fluidic 1166
- Male Mini Luer Fluid connectors
- Male Mini Luer plug - low volume displacement
- Silicon sleeve (cut from silicone tube)
- PTFE tubing
- Pump system of your choice (e.g. pressure-driven pump with at least two channels)

Optional:

- Mini Luer to pipette adapter
- Handling frame

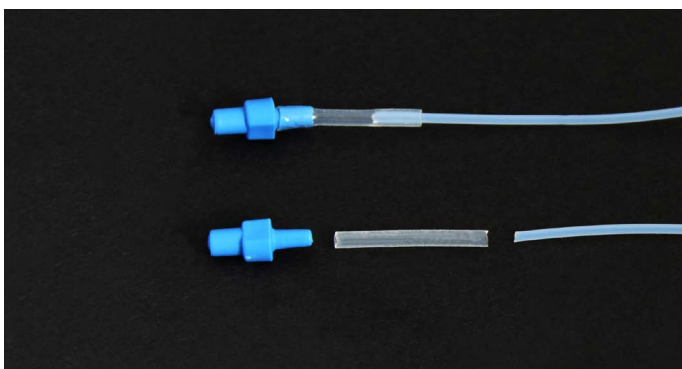
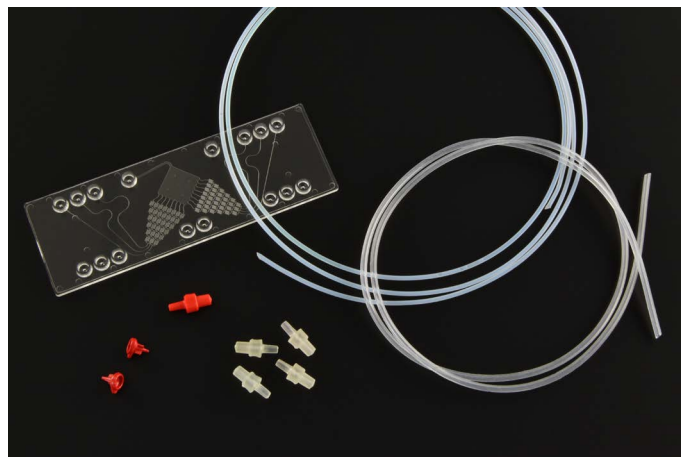

Assemble setup

- Connect Mini Luer connectors with silicone sleeves
- Insert PTFE tubing into silicone sleeves
- Connect PTFE tubing with pumps
- Place chip in the handling frame
- Connect Mini Luer to pipette adapter with outlet

Prepare chip

- Pre-fill the chamber and all channels with liquid through the outlet (see following page)
- Outlet: replace pipette adapter with connector and tubing leading to waste container
- Connect tubing to pump of your choice
- Start pumps and wait for a droplet to form at the tip of the connector
- Input: Insert Mini Luer connectors into Mini Luer interfaces
- Close unused Mini Luer ports with Mini Luer plugs

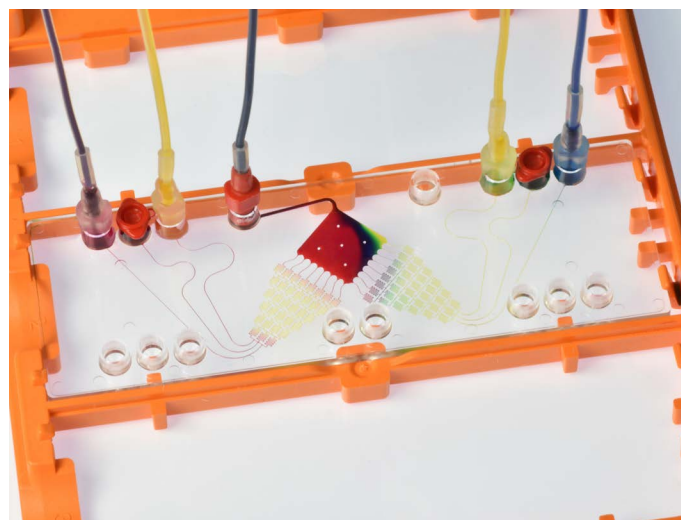

Create a gradient

- Adjust flow rates according to gradient needed (see following page)



Application example: creating a color gradient

The 2D Gradient Generator in this example was used to create a color gradient of yellow and red media on one side and blue and green media on the other. The following figures show, how flow speed of the media impacts the gradient. The lower the flow rate is set, the more diffuse the gradient becomes due to an increased residence time.

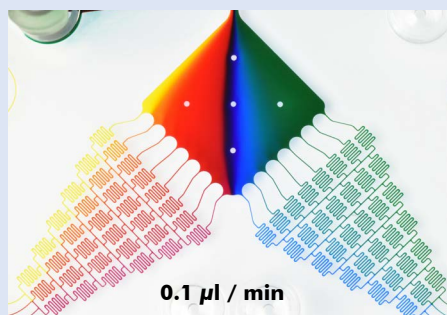

Low flow rates (each channel 0.1 µl/min) lead to a gradient with soft transitions.

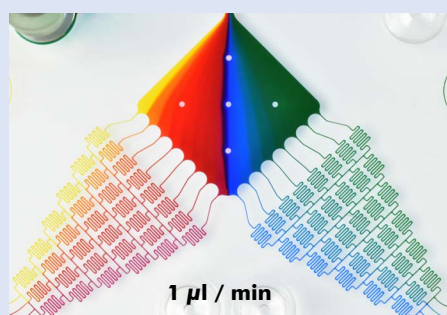

Increasing the flow rates (here: 1 µl/min) changes the shape of the gradient. Flow rates can be altered for each channel individually if necessary.

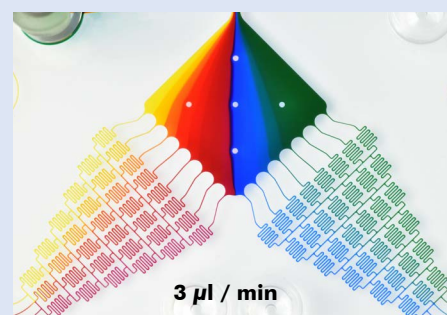

Higher flow rates (each channel 3 µl/min) create a less diffuse gradient.

Hacks for handling 2D Gradient Generator chip Fluidic 1166

It is crucial to remove all air from the chamber and the serpentine before generating your gradient. Avoid trapping air in the chamber and channels by following these tips:

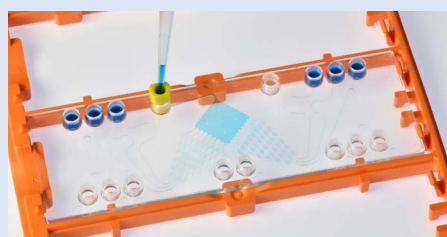

Prefill the chip with water or media of your choice through the outlet using a pipette adapter and a pipette. Let the liquid rise up into the input interface.



Before assembling the tubing to the chip, make sure all air has been removed from syringes and tubing by forming a droplet at the end of the connector.



When sealing unused inlet interfaces, apply Mini Luer plugs with low volume displacement. Fill the inlet interface with media before applying the plug to avoid trapping air.

Product Code for Fluidic 1166	Description	Lid Thickness [µm]	Material	Surface Treatment	Price [€/chip]		
					1+	10+	100+
10001572	2D gradient generator	140	Topas	-	36.20	24.30	16.10
10001573	2D gradient generator	125	PS	-	36.20	24.30	16.10
10001574	2D gradient generator	140	Topas	hydrophilized	39.20	26.30	17.80
10001575	2D gradient generator	125	PS	hydrophilized	39.20	26.30	17.80

Product Code	Description of Accessories	Material	Quantity	Price [€]		
				1+	5+	10+
10000096	Male Mini Luer fluid connector	PP - Blue	10 pcs / pack	19.00	14.00	9.40
10000280	Male Mini Luer plugs – Low volume displacement	PP - Red	10 pcs / pack	19.00	14.00	9.40
10000057	Mini Luer to pipette adapter	PP - Yellow	10 pcs / pack	19.00		9.40
10000031	Silicone tube, ID: 0.76 mm, OD: 1.65 mm	Silicone	1 m		9.50	
10000032	Micro tubes, PTFE, ID: 0.5 mm, OD: 1.0 mm	PTFE	1 m		9.50	
10000043	Handling frame with high skirt, orange	PC	1 pc	22.00	15.00	12.40

microfluidic ChipShop GmbH

Stockholmer Str. 20 • 07747 Jena • Germany
 Phone: +49 (0) 3641 34705-0 • Fax: +49 (0) 3641 34705-09
inquiries@microfluidic-ChipShop.com • www.microfluidic-ChipShop.com

ApJHF1166V1

