

Manual of HPM Series

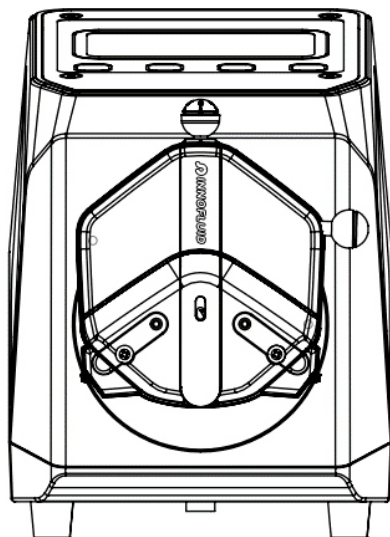

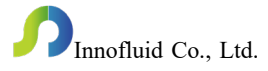





**Note:**

- Please read the manual carefully before operating the product. This safety information should be read in conjunction with the rest of the operator's manual.
- Please read and understand the contents of this manual carefully and use it according to the specified methods.

**Warning:**

- This product is not allowed to be put into water for operation.
- IP66 pumps are supplied with a power plug, the power plug on the other end of the cable is not IP66 rated. It is the user's responsibility to ensure the IP rating of the power connection.
- This product is not applicable to explosion-proof directives and must not be used in explosive environments.
- If the automatic restart function is enabled, it may cause the system to start running immediately after power-on. The automatic restart function only applies to transfer mode. If the automatic restart function is enabled, a warning  will be displayed in the upper left corner of the screen.
- Do not install the pump in a confined area where air circulation is restricted.
- Connect the power cord to the wall socket directly, and avoid using the extended electric wire.
- If the power cord or plug had wear and other damage, please disconnect the plug. (Hold the plug instead of the wire)
- The pump is forbidden to running in the water.
- If following situations happened, please turn off the power supply and disconnect the plug. (Hold the plug instead of the wire)
 1. The pump head is leaking or the cover fails to open.
 2. You think the pump need to maintain or repair.
- The user's power socket must have ground wire, and have reliable grounding.

Note: The foot pedal switch and other external control plugs must be connected or disconnected in the power-off status to prevent the external control interface from being burned.

	Pay attention to electrical safety.
	It is strictly forbidden to connect wires with power on.
	<p>There are moving parts inside the pump head. Please make sure to follow the following safety instructions before opening the pump head:</p> <ol style="list-style-type: none">1. Make sure the pump is disconnected from the main power supply;2. Make sure there is no pressure in the pipeline.

Catalogue

1. Product Introduction	- 1 -
2. Product Appearance and Interface Instruction	- 1 -
3. Operation Panel Instruction	- 2 -
4. Operation Interface Structure.....	- 2 -
5. External Control Interface Instruction	- 22 -
6. Technical Specification.....	- 29 -
7. Functions and Features	- 30 -
8. Suitable Pump Head and Tubing	- 31 -
9. Troubleshooting.....	- 31 -
10. Maintenance	- 32 -
11. Warranty and After-sales Service.....	- 33 -

1. Product Introduction

HPM series products are high IP rate intelligent peristaltic pump, the IP rate of whole machine housing is IP66. Adopts 4.3 inch color touch screen control; The working state is animation display. Dispensing data, setting parameters and system settings are displayed in the same screen. Intelligent calibration and online micro adjusting function; three measurement modes: fixed volume measurement, dispensing, speed dispensing. Three-level permission functionality. It can load different pump heads, multiple external methods are optional.

This series include three product model: HPM600, HPM300, HPM100.

Suitable pump head: EasyPump pump head, DZ25-3L pump head, AMC series pump head.

2. Product Appearance and Interface Instruction

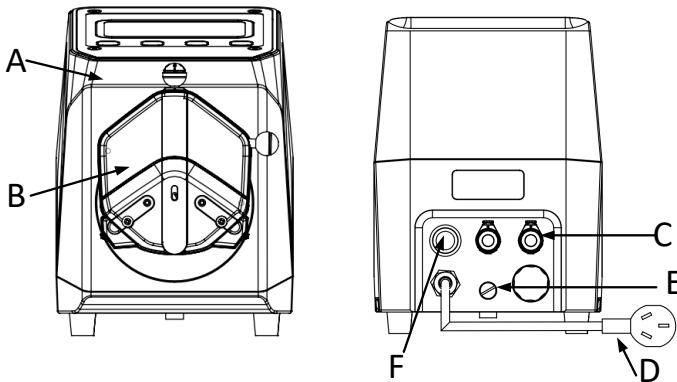

A—Drive

C—External Control Interface

E—Grounding Post

B—Pump Head

D—Power Wiring

F—Power Switch

3. Operation Panel Instruction

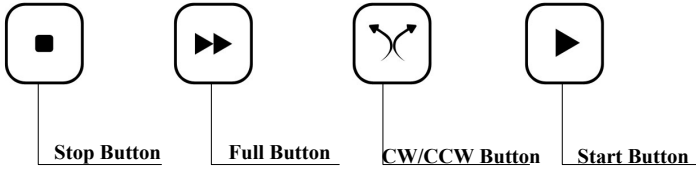

- **Stop Button:** Press Stop button, pump stops working. Forbidden buttons in the main interface can be used. Keep pressing the button and turn on the pump power supply, that will initialize the pump and all the parameters will be lost.
- **Full Button:** At stopping state or transferring state, press this button, the pump will run with the highest speed. This button can be used for washing tube or fast filling liquid.
- **CW/CCW Button:** Press this button once, the motor will change running direction once. During the operation of liquid volume distribution, this button does not work.
- **Start Button:** Press this button, the motor starts running. When the liquid volume distribution function is enabled, press this button, the pump will start work with the function.

When the key lock function is turned on, you need to press and hold the Start and CW/CCW buttons at the same time to unlock the panel buttons.

4. Operation Interface Structure

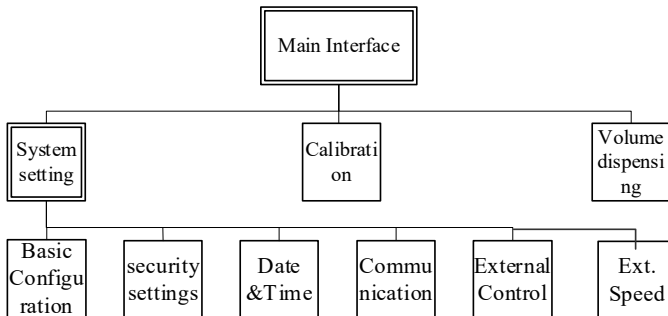

HPM Series Operation Interface Instruction

4.1 Booting Interface

After turn on the system, enter the welcome interface, click anywhere or wait for 2.5 seconds it will enter the English main operation interface automatically.

4.2 Main Interface

Main Interface Composition as below:

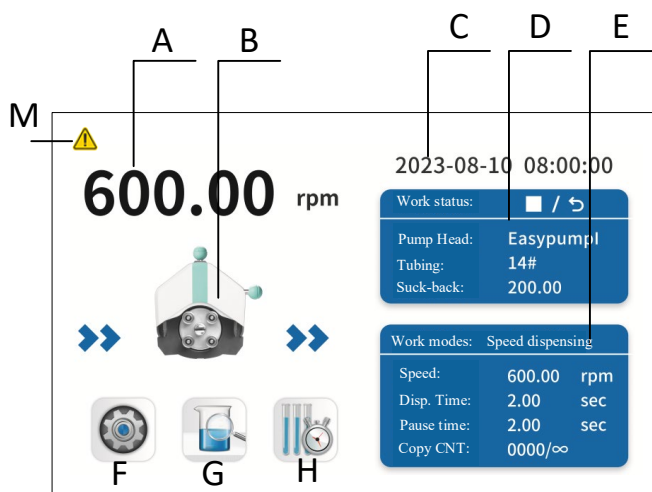



A. Speed/Flow Rate Display: In transmission mode, the current display can be set as speed or flow rate on the pump head hose interface, In the flow rate mode, displays the current flow rate. In the speed mode, displays the current set up speed. Click A to amend the flow rate or speed.

In dispensing mode: When Dispensing function is turned on, A is forbidden, the current filling volume can be displayed; When fixed volume measurement is on, the flow rate can be displayed at the area and the volume can be modified; When the speed dispensing is turned on, the speed can be displayed at the area, and can not be allowed to amend.

B. Real-time Animation Display: Real-time display of the current running status.

- C. Date and Time Display:** Display the current date and time, you can change it in the system settings.
- D. Setting Parameter Display:** Display current working status, ◀: operation status; ■: stop status; ◀◀: full speed status; ↶: counterclockwise; ↷: clockwise; Pump head mode, tubing size and back suction can be displayed at the same time.
- E. Current Working Parameter Display:** Display current working mode and real-time parameter.
- F. System Settings Button:** Click this button, set up other parameters.
- G. Flow Calibration Button:** Click this button to enter the flow rate calibration interface.
- H. Dispensing Button:** Click this button, enter dispensing parameter setting interface.
- M. Tips and Warnings:** When the corresponding function is turned on, the following prompt logo will appear on the main interface.

The mark of tips	The content of tips	Methods for relieving prompts	Special instructions
	Automatic restart function turned on	Enter the external control setting interface to turn off this function.	
	Leakage from the pump head is detected	Turn off the power to the pump and eliminate leakage from the pump head.	Need to be equipped with corresponding detection sensors
	It is detected that the pump head cover is opened	Turn off the pump power and troubleshoot the pump head	A pump head with this function is required

4.3 Numeric Keypad Input Interface

Numeric keypad input interface as below:

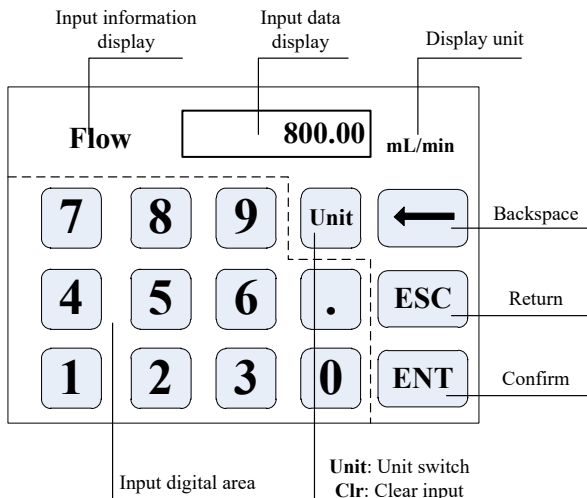

Input Information Display: The information displayed is the current operation object.

Input Data Display: Display the current input data, range is 0.01-9999.

Unit Display: Display input units when input flow rate or volume.

Input Digital Area: Numeric keypad.

Unit/Clr Button: When input flow rate or volume, this button is unit switch, you can choose different input units. When it is Clr, you can clear the current input data.

Backspace Button: Delete an input digital.

ESC Button: Cancel the current input, back to previous interface.

ENT Button: Confirm the current input.

4.4 Menu Select Interface

Press system setting button in main interface, then enter to menu interface:



4.4.1 The Basic Configuration Interface

The basic configuration interface:

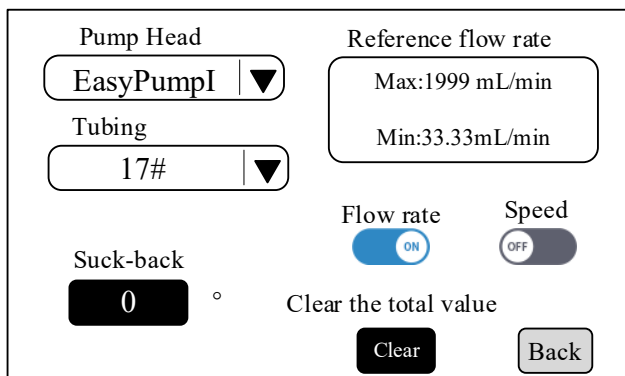

Click the **Pump Head** and **Tubing Size** to choose the pump head and tubing.

The maximum and minimum flow rate with the current pump head and tubing are displayed at the Reference flow rate.

In transferring mode, click Flow rate button or Speed mode button to choose the operation mode. After choosing flow rate mode, the flow rate can be adjusted, the

flow rate will be changed with the flow rate; After choosing speed mode, the speed can be adjusted, the flow rate will be changed with speed.

Click the back button when you had finished choosing parameter then back to the system setting interface.

Note that: When the pump come with two pump heads, the output of two pump heads are connected to one channel with Y type connector, then you will need to choose 2* pump head model; Other cases require the selection of a separate pump head model.

For example, the pump come with two EasyPumpI, and output connect with Y type connector to one channel, then when choose pump head need to select 2*EasypumpI, as in below picture:

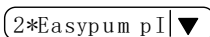

In other cases, such as: the pump come with one pump head EasypumpI, or with two EasypumpI use as two channels, or with 3 or 4 EasypumpI pump heads, need to select single pump head EasypumpI, as in below picture:

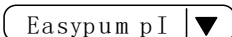

Suck-back button: Set the suction angle value when stopping, the range is 0-360°. When the value is 0, it means there is no suction back when the operation is stopped. When the value is 360, it means one circle of sucking back when the operation stops.

Clear the total value button: After click this button, the total liquid volume and total time accumulated during transmission are cleared to zero.

4.4.2 Security Setting Interface

The interface for setting the operation password is as shown below

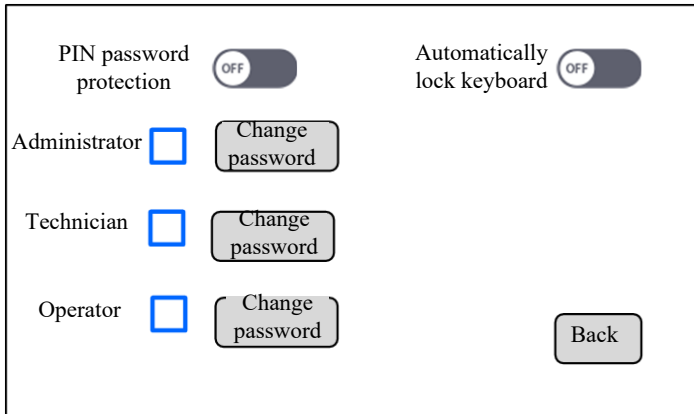

In menu interface, click **Security Setting** button to enter security setting interface.

1) Three-level permission setting

You can turn on the Three-level permission function in Security setting interface. The Three-level permission are divided into administrator, technician and operator. The administrator has all permissions, and the technician and operator have permissions and passwords assigned by the administrator. The default password for the administrator is 1234 when used for the first time; if you forget all passwords and need to restore the pump to factory settings, you can restore the third-level administrator password to the default value.

The three-level permission function can be enabled by changing the "PIN password protection" on the main interface from OFF to ON. At this time, you need to enter the administrator password. The password for the first use is 1234. When the password is entered correctly, the following prompt will pop up, and the third-level permission function will be enabled. At this time, it is administrator mode. The administrator needs to set passwords and assign permissions to technicians and operators.

Tips



All functions are protected by a PIN code.
Activation of these functions requires technician and operator authorization to operate the function.

OK

The following uses "technician" as an example to explain:

Pin password protection

Automatically lock keyboard

Administrator	<input checked="" type="checkbox"/>	<input type="text" value="Change password"/>	
Technician	<input type="checkbox"/>	<input type="text" value="Change password"/>	
Operator	<input type="checkbox"/>	<input type="text" value="Change password"/>	

Pin password protect

Automatically lock keyboard

Set password 1111

Administrator	<input type="checkbox"/>	<input type="text" value="Change password"/>	
Technician	<input type="checkbox"/>	<input type="text" value="Change password"/>	
Operator	<input type="checkbox"/>	<input type="text" value="Change password"/>	

Step 1: Click the selection box on the technician side, and the password setting interface will pop up. At this time, the administrator needs to set a password for the technician. After setting the password, click the "ENT" button to enter the "User Permission Setting" interface.

User permission setting interface	
Start/stop <input checked="" type="checkbox"/>	Calibration <input checked="" type="checkbox"/>
Direction <input checked="" type="checkbox"/>	Basic setting <input type="checkbox"/>
Full speed <input checked="" type="checkbox"/>	Dispensing <input type="checkbox"/>
Button lock <input checked="" type="checkbox"/>	Communication <input type="checkbox"/>
Adjust speed/flow rate <input checked="" type="checkbox"/>	External control <input type="checkbox"/>
Change password <input checked="" type="checkbox"/>	Analog speed control <input type="checkbox"/>
<input type="button" value="Back"/>	

Step 2: The administrator needs to assign permissions to technicians in the "User Permission Operation" interface. The permission functions are described as follows:

Function	Explanation	Function	Explanation
Start/stop	Panel start/stop button operation permissions	Calibration	Calibrate the pump flow rate. Refer to Section 4.5
Direction	Panel direction button operation permissions	Basic setting	Pump basic setting. Refer to Section 4.4.1
Full speed	Panel full speed button operation permissions	Dispensing setting	Pump dispensing parameter setting. Refer to Section 4.6
Keypad lock	Security settings interface key lock Refer to section 4.4.2 for	Communication	Pump communication parameter setting.

	permission to enable or disable functions.		Refer to Section 4.4.4
Adjust speed/flow rate	Modify the speed and flow value of the main interface in transmission mode. Refer to Section 4.2 A for instructions.	External control	Pump external control setting. Refer to Section 4.4.5
Change password	Change your login password	Analog speed control	For pump analog debugging parameter settings, refer to Section 4.4.6

After setting permissions, click the Back button to return to the security settings interface. At this point, the technician permissions setting is complete.

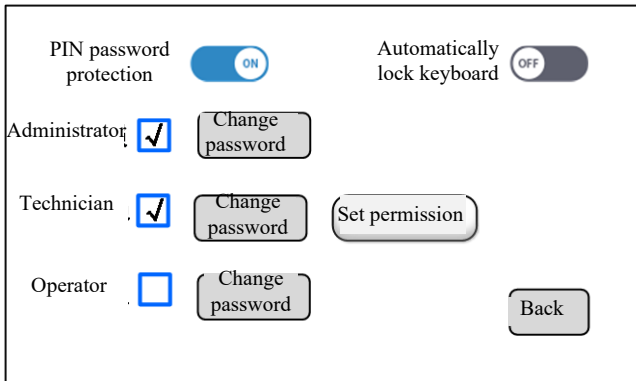

The above picture shows the interface after setting the technician's password and permissions. The **Change password** button can be used to modify the password of the technician; The **Set permission** button can be used to enter the user permission settings interface again to modify permissions; Only administrators have the authority to enter and set

permissions in the user permission setting interface.

2) Automatic keyboard lock function

After the automatic keyboard lock function is turned on, if there is no key operation within 20 seconds, the three buttons on the main panel: full speed button, reversing button and start button will be locked to prevent misoperation. Special note: The stop button is not locked.

To unlock the key lock, press and hold the start and reverse keys at the same time.

Note: When the third-level permission function is not enabled, the automatic keyboard lock can be used. If the third-level permission is enabled and the currently logged in user does not have the permission to enable this function, the function cannot be enabled.

3) Login interface

When the three-level permission function is enabled, when the pump is turned on again, the user login interface will pop up first, as shown below:

User login interface	
Administrator	<input type="checkbox"/>
User1	<input type="checkbox"/>
User2	<input type="checkbox"/>

Click on the right side of the administrator, and a password input keyboard will pop up. Enter the password to enter the pump main interface. If the password is wrong, a prompt will be given and the interface will remain.

4.4.3 Date and Time Setting Interface

Setting Date & Time Interface as below:

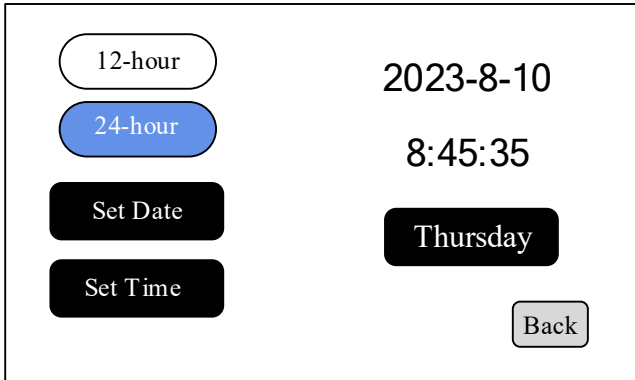

In this interface, you can set the current date and time, it will be displayed at the top right corner. You can change the display format to 12-hour or 24-hour. Click **Set Date** button, **Set year** numeric keypad will be come out, the set range of the year is **1970-2099**. After set up the year, then set the month and date.

Click **Set Time** button, the numeric keypad will be come out, and set hours, minutes and seconds in sequence.

4.4.4 Set Communication Interface

Communication setting interface is as shown as below

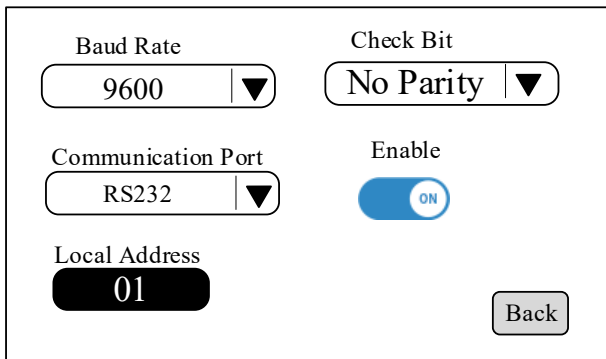

Click Communication Setting Button in menu interface then enter to communication setting interface.

This pump supports Modbus communication protocol -- RTU Mode.

Communication baud rate: 1200, 2400, 4800, 9600, 19200; the default is 9600;

Check bit: None Parity, odd parity, even parity; the default is even parity.

Communication interface: RS485

Click Local address button to input the peristaltic pump address No. (the range is 1-32).

Choose communication enable to ON, at this time, the pump will communication with host machine and receive host machine signal.

Note: After settings, the peristaltic pump only receives communication signal control when in the main interface, it is invalid for the communication control in the other settings interface.

Please refer to the communication protocol for specific communication rules.

4.4.5 External Control Setting Interface

The external control setting interface is shown as below

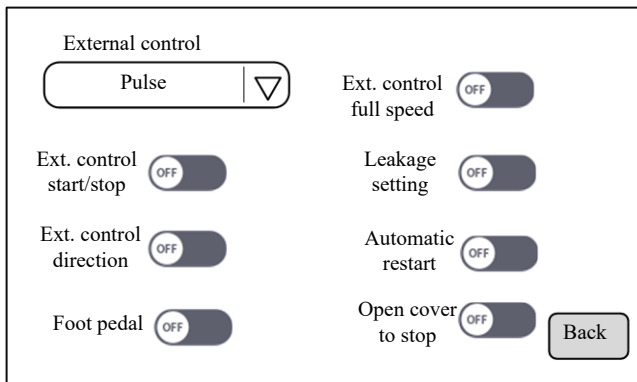

Click **External control setting** button in menu interface then enter to external control setting interface.

External control start/stop and **external control direction** signals are divided into two types: Level and pulse. The signal type is active signal and 5-24V universal.

Foot pedal setting signals are divided into two types: Level and pulse. The signal type is passive signal.

External control full speed: The signal is level method, the signal type is active signal and 5-24V universal.



Leakage setting: The signal is level method, after turning on this function, it can be detected only with external sensors.

Note: Various external control modes are independently set on switches, which will only work after the corresponding external control function is turned on.

For specific interfaces, see the description of the external control interface.

Automatic restart function: After turning on this function, when the pump is running in transmission mode and the pump suddenly loses power and then re-energizes it, the pump will start running according to the original set parameters.

When this function is turned off, when the pump is running in transmission mode and the pump is powered off and on again, the pump will be in a stopped state and no self-start event will occur. It is recommended to turn off this feature.

Notice	
	<p>If the auto-restart feature is enabled, it may cause the system to start running immediately after power-up. The auto-restart feature is only available in transfer mode.</p> <p>If the automatic restart feature is enabled, there will be a warning prompt  in the upper left corner of the screen.</p>

Open head to stop: This is only available if the currently selected pump head has the cover-opening stop function. For example, when the EasypumpI pump head is selected and the cover-opening stop function is turned on, the pump will stop working when the pump head cover is opened. For the prompt icon on the upper left of the main interface, refer to the instructions in Section M in Section 4.2. When the

pump head cover is closed, the pump will not start automatically and the operator needs to manually start the pump.

4.4.6 External Control Analog Speed Interface

The external control analog speed interface is shown as below

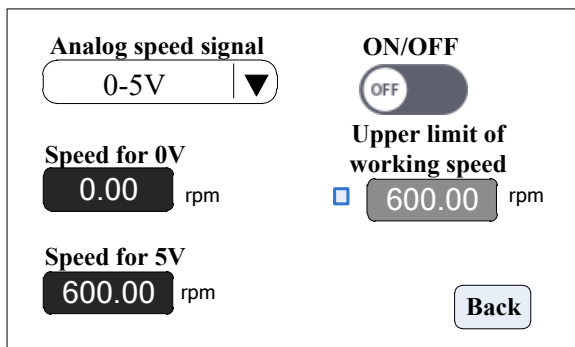

The screenshot displays a control interface with the following elements:

- Analog speed signal:** A dropdown menu currently set to "0-5V".
- Speed for 0V:** A digital display showing "0.00 rpm".
- Speed for 5V:** A digital display showing "600.00 rpm".
- ON/OFF:** A toggle switch currently in the "OFF" position.
- Upper limit of working speed:** A digital display showing "600.00 rpm" with a small square icon to its left.
- Back:** A button located at the bottom right of the interface.

Click **External control speed** button in the menu interface, then enter External Speed Control Settings interface.

According to external input signal to set the analog speed signal: **0-5V, 0-10V and 4-20mA**. External control speed regulation can set the maximum speed of the pump. When the maximum speed is 600 rpm, the analog signal voltage range has a linear relationship with the motor speed.

If the upper limit of the working speed is turned on and the setting is not 600 rpm, the motor speed will be limited by the analog signal. When the motor speed and the analog signal amount reach the set maximum speed according to the corresponding proportional relationship, at this time, add the analog signal, the motor speed will run at the set maximum speed and will no longer increase with the analog signal quantity. (For example: 0V corresponds to a speed of 0 rpm, 5V corresponds to a speed of 600 rpm (2.5V should be 300 rpm), the upper limit of the operating speed is set to 300 rpm, and if the external input analog signal is 2.5V, at this time, the motor speed is 300 rpm. When the input signal exceeds 2.5V, the motor speed remains at 300 rpm.)

4.5 Calibration Interface

Click calibration button in main interface to enter to calibration interface, and it is shown as below:

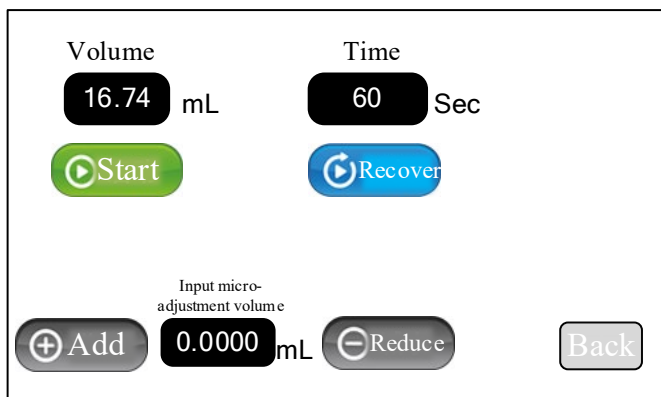

The operation steps for transferring mode:

- After entering this interface under transferring mode, the default test time is 60s, the actual volume is default to the volume displayed according to current setting volume.
- Click Start button, the motor will start running and the calibration will be started. At this time, the button turns gray.
- When the running time is up, it will automatically stop. A numeric keyboard for entering the actual measured liquid volume will pop up. Enter the actual measured liquid volume and click the OK button. The "Calibration Complete" dialog box will pop up, that is, the calibration is completed.
- Click Start button during the pump operation to stop this calibration process.
- Restore calibration function: Click Restore button, a prompt dialog box pops up on the interface to restore the calibration coefficients.

Note: After calibration, return to the main interface, the rotation speed remains unchanged, and the flow rate changes according to the actual value calibrated.

For example: The rotation speed is 100 rpm, the original corresponding flow rate is

20 mL/min, and the actual liquid volume tested in 60 seconds is 22 mL. After the calibration is performed, the main interface shows that the rotation speed is 100 rpm and the flow rate is 22 mL/min.

The operation steps for dispensing mode:

- a. Enter this interface under dispensing mode, test time (flow rate) and actual liquid volume are default to the currently assigned parameter settings.
- b. Press Start button, the motor starts running and calibrating. At this time, this key is turned to gray.
- c. After the pump stops running, a numeric keyboard for entering the actual measured liquid volume will pop up. Enter the actual measured liquid volume and click the OK button. The "Calibration Complete" dialog box will pop up, that is, the calibration is completed.
- d. Click Start button during pump operation to stop this calibration process.
- e. Restore calibration function: Click Restore button, a prompt dialog box pops up on the interface to restore the calibration coefficients.

Note: When the calibration coefficient is changed, all parameters need to be recalculated, which may cause the parameters of a certain function to produce unreasonable speed. In order to prevent this from happening, it is recommended to reset the parameters after modifying the operating mode.

Speed distribution mode does not require calibration.

The process of fine-tuning the liquid volume is as follows:

- a. Enter the fine-tuning liquid volume value in the liquid volume box.
- b. Click Add or reduce liquid volume to reach micro adjustment.

4.6 Dispensing Interface

In main interface, click volume dispensing button to enter to volume dispensing interface.

Liquid volume dispensing can be divided into three modes: Dispensing, fixed volume measurement, speed dispensing: firstly, you need to turn on dispensing function.

4.6.1 Dispensing Interface

The dispensing interface is shown as below

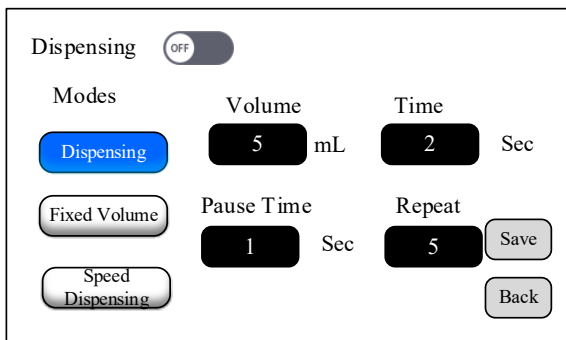

Click **Dispensing** Button in this interface to start the dispensing function.

The right side shows the liquid volume, running time, interval time and number of repetitions, and the parameters can be set separately. The peristaltic pump automatically measures the total liquid volume and time for transmission, and stops automatically when the liquid volume reaches the set value.

Volume range: 0.1-9999.99; Unit: μ L, mL and L;

Operation time: 0.1-9999.99; Unit: sec, min and hour;

Pause time: 0.5 sec-9999.99 hour;

Repeat time: 1-9999; 0 means unlimited times;

After setting the parameters, the Dispensing button on the left is displayed as shown

in the figure  , it indicates that the parameters have not been saved at this time. You need to click the Save button and the parameters are set successfully. If the set parameters are unreasonable, you will be prompted when you click the save button and exit the save.

Click Back button, back to main interface, at this time, the pump working mode is dispensing mode, the parameter settings for dispensing are displayed in the blue box in the lower right corner of the main interface.

4.6.2 Fixed Volume Dispensing Interface

The fixed volume interface is shown as below

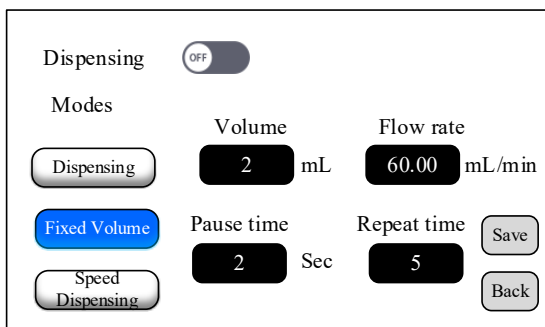

Click Fixed volume button to start fixed volume dispensing function.

Set parameters such as display liquid volume, flow rate, interval time, and number of repetitions separately; The peristaltic pump automatically measures the total liquid volume and time for transmission, and stops automatically when the liquid volume reaches the set value.

The volume range: 0.1-9999.99; Unit: μ L, mL and L;

The flow rate range: Depending on the pump head hose, the flow range is different. Unit: μ L/min, mL/min, L/min;

Pause time: 0.5 sec-9999.99 hour;

Repeat times: 1-9999; 0 means unlimited times;

After setting the parameters, the Fixed volume button on the left is displayed as

shown in the figure , it indicates that the parameters have not been saved at this time. You need to click the Save button and the parameters are set successfully. If the set parameters are unreasonable, you will be prompted when you click the save button and exit the save.

Click Back button, back to main interface, at this time, the pump working mode is fixed volume mode, the parameter settings for fixed volume are displayed in the blue box in the lower right corner of the main interface.

4.6.3 Speed Dispensing Interface

The speed dispensing interface is shown as below

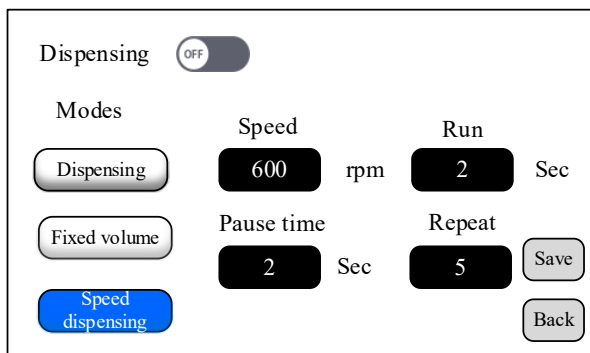

Click Speed dispensing button to start speed dispensing function.

Set parameters such as speed, operation time, interval time, and number of repetitions separately; The peristaltic pump automatically stops after running for a certain time.

The speed range: 0.1-maximum speed;

Operation time: 0.1-9999.99; Unit: sec, min, hour;

Pause time: 0.5 sec-9999.99 hour;



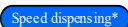

Repeat times: 1-9999; 0 means unlimited times;

After setting the parameters, the Fixed volume button on the left is displayed as

shown in the figure , it indicates that the parameters have not been saved at this time. You need to click the Save button and the parameters are set successfully. If the set parameters are unreasonable, you will be prompted when you click the save button and exit the save.

Click Back button, back to main interface, at this time, the pump working mode is speed dispensing mode, the parameter settings for speed dispensing are displayed in the blue box in the lower right corner of the main interface.

5. External Control Interface Instruction

Notice	
	The correct signal must be provided to the pins as indicated in the instructions, and the signal value must not exceed the specified range. If the wrong pins are connected, the external control interface may be burned, causing permanent damage.
	The analog speed control signal must be isolated from the main power supply. Please use an independent shielded grounded input line. It is recommended to comply with EMC requirements.
	Ensure that the pins at the ends of multiple cables do not overlap each other, otherwise the external control interface may burn out and cause permanent damage.
	You must use connectors with a protection level of IP66, otherwise the IP66 protection level may not be achieved.
	Make sure the external control interface is covered with a waterproof plug when not in use. Failure to do so may affect the protection level.

External control interface as below:

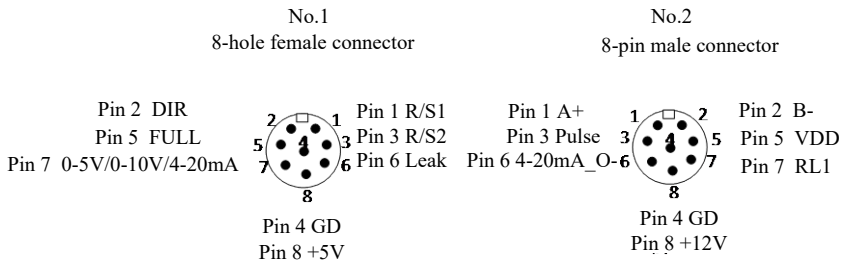

No.1 8-hole female connector

External control start/stop and direction signal input port: Active signal input, 5-24VDC input.

- ① R/S 1: External control start/stop signal input
- ② DIR: External control direction signal input

Set the external control signal mode (pulse/level mode) in the external control setting interface, turn on the corresponding external control function, and the signal at the external control signal input terminal is valid.

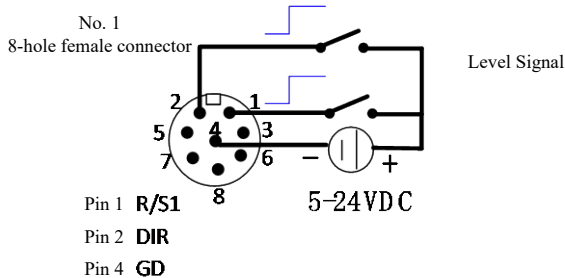
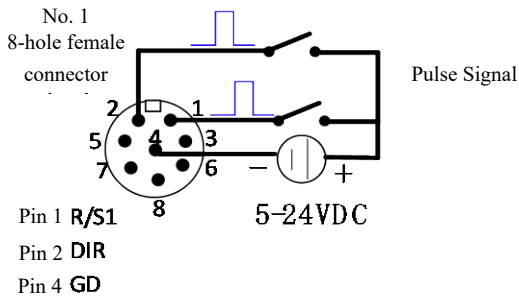

Notice	
	Active voltage signal is 5-24V, do not exceed this range.

External control start/stop signal input port: Passive signal input (Our company's

handheld dispenser and foot pedal interface)

③ R/S 2: External control start/stop signal

The passive switch or foot pedal switch can be connected with the terminal. Set the validity of this input in external setting interface--foot pedal option. Note that: It should be noted that in level mode, the foot switch and external control start and stop cannot be turned on at the same time.

Set the external control signal mode (pulse/level mode) on the external control setting interface, turn on the corresponding external control function, and the external control signal input signal is valid.

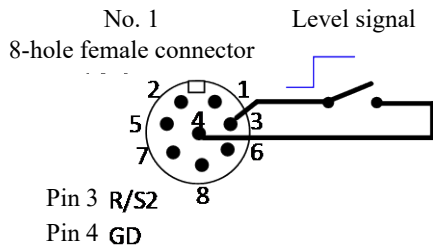
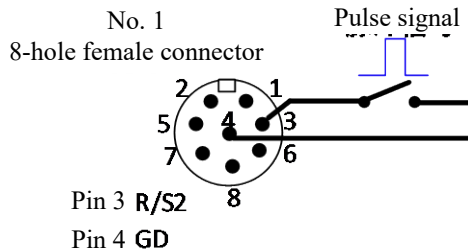

- ④ Full: External control full speed signal input, external control full speed

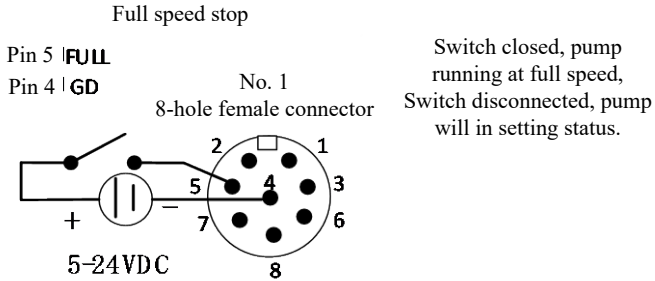

- ⑤ Leak detection: After turning on the Leak detection function on external control setting interface, connect a line between ports Leak and GD, the example is as follows: when the switch is closed, there is a warning sign in the upper left corner of the main interface. When it is disconnected, the warning sign in the upper left corner of the main interface disappears.

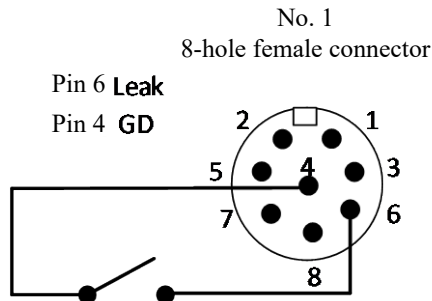

- ⑥ Analog signal input port: After selecting the external control speed regulation signal in the external control setting interface, the external control speed regulation function is turned on, and the motor speed is controlled from 0rpm to the maximum speed through the analog signal.

Pin 7 0-5V/0-10V/4-20mA: 0V to 5V voltage signal /0V to 10V voltage signal /4 to 20mA current signal input port.

GD: Analog signal negative port.

Switching the analog speed control signal requires modifying it through the drop-down list in the analog speed control interface.

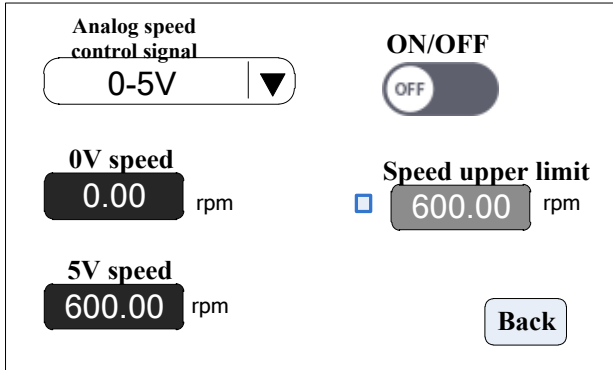

Taking 0-5V analog signal as an example, the wiring diagram is as follows

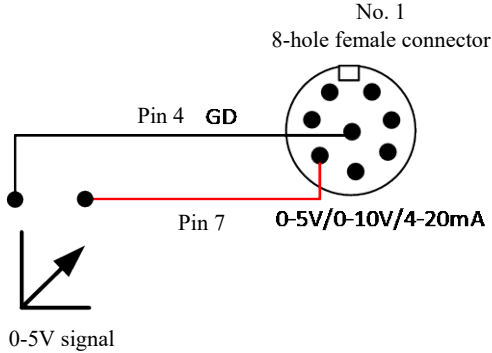

No.2 8-pin male connector

① Communication port

RS485 communication port: Choose RS485 port in communication setting interface, this port is valid.

A+: Connected with RS485 A+ port

B-: Connected with RS485 B- port

Note: The communication protocol is the standard MODBUS protocol.

② The output port of motor running status: Outputs motor running status

RL1: Running status output port OUT, this port is open collector output.

VDD: External power supply positive (VDD) in operation status, the power supply can be between 5-24V.

GD: External power supply negative (GD) in operation status.

The schematic diagram of the external relay is as follows:

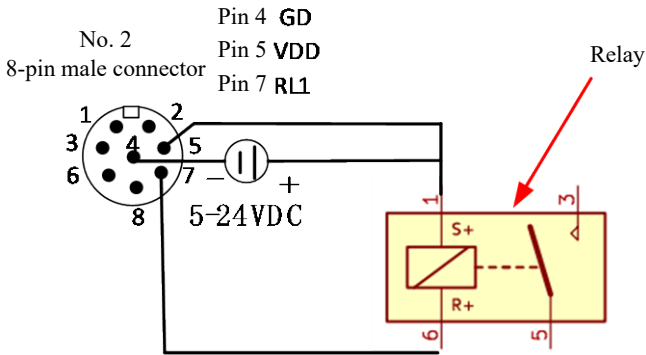

If it connects with external relays, when the motor is running, the relay will close, and when it stops, the relay will disconnect.

③ Pulse output port: Output speed 0.1rpm-SpeedMax corresponds to a pulse frequency of 600Hz-3000Hz. (SpeedMax is 150, 350, 600rpm)

the wiring diagram is as follows:

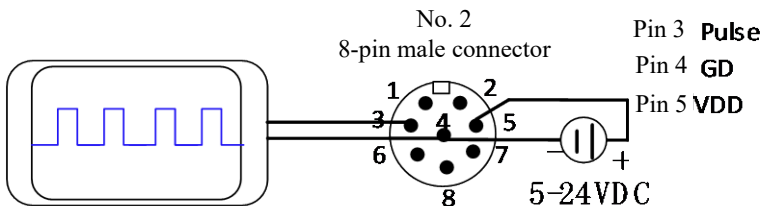

④ 4-20mA analog output port:

The output speed 0.1rpm-SpeedMax corresponds to the analog output of 4-20mA. (SpeedMax is 150, 350, 600rpm). Taking SpeedMax=600rpm as an example, modify 0.1rpm to output 4mA, 300rpm to output 12mA, and 600rpm to output 20mA.

the wiring diagram is as follows:

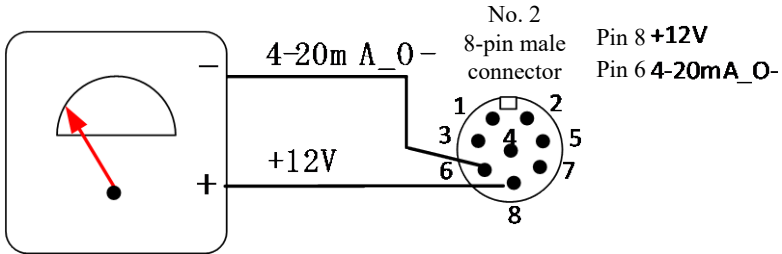

Notice



The external control line must use a data line with a shielding layer, and the shielding layer must be grounded.

6. Technical Specification

Drive type	HPM600	Speed range	0.1-600rpm
	HPM300		0.1-350rpm
	HPM100		0.1-150rpm
Flow rate resolution	0.01mL/min	Power supply	AC 110V-220V±10% 50Hz/60Hz
Operation method	Touch screen and mechanical keypad	External control method	Switch signal
External control speed regulation	0-5V, 0-10V, 4-20mA for option	External control method	Passive switch signal: like foot pedal switch Active switch signal: 5-24V universal
Communication method	RS485, supports Modbus protocol (RTU mode)	Output interface	Output motor running status (Open collector output)
Pulse output	600-3000Hz	Analog output	4-20mA
Back suction angle	0-360°	IP rate	IP66
Temperature	0-40°C	Relative Humidity	<100%

7. Functions and Features

- 4.3 inch color touch screen control, animation shows working state, the flow volume and motor speed are displayed in the same screen.
- Intelligent calibration function, it can calibrate the flow rate and dispensing volume, ensure the flow accuracy, suitable for high accuracy transferring liquid.
- Accurate angle control technology, reach high precision dispensing and measurement.
- Fixed volume measurement function: After enabling this function, the peristaltic pump automatically measures the total liquid volume transmitted. When the liquid volume reaches the set value, it automatically stops, and the flow rate can be changed freely during this process.
- Dispensing function: After turn on this function, the peristaltic pump will transfer fixed volume within set time. It is suitable for liquid dispensing in industrial production.
- Speed dispensing function: After turning on this function, liquid will be distributed according to a fixed speed and time.
- Power down memory function, store the running parameters in time, safe and reliable.
- Fast fluid-filled function, can wash the tubing and also fill fluid in the tubing.
- High torque and low power loss, it can load several pump heads or multichannel pump head, meet different application requests.
- External control start and stop, convenient for equipment supporting.

8. Suitable Pump Head and Tubing

Pump head	Suitable hose /silicone tubing	Reference flow rate (ml/min)	Overall dimensions (length x width x height)
EasyPump	13#, 14#, 19#, 16#, 25#, 17#, 18#, 15#,24#, 35#, 36#	0.0053-3100	336x160x221
DZ25-3L	15#, 24#, 35#, 36#	0.211-3600	332x160x221
AMC(10)	1*1, 2*1, 2.4*0.8, 3*1, 0.13*0.86, 0.19*0.86, 0.25*0.86, 0.51*0.86, 0.89*0.86, 1.14*0.86, 1.42*0.86, 2.06*0.86, 2.79*0.86	0.005-42.86	AMC (10) pump head 10-channel 399x160x221
AMC(6)	1*1, 2*1, 2.4*0.8, 3*1, 0.13*0.86, 0.19*0.86, 0.25*0.86, 0.51*0.86, 0.89*0.86, 1.14*0.86, 1.42*0.86, 2.06*0.86, 2.79*0.86	0.0062-55.77	AMC (6) pump head 10-channel 399x160x221

9. Troubleshooting

If the screen is black and there is no display after powering on, the following checks should be performed:

- Check if the power supply of the pump is normal.
- Check if the power cord is damaged or broken.
- Check if the power switch of the pump is pressed and the green light is always on.

If the pump is running with very low or no flow, perform the following checks:

- Check if the liquid at the inlet is normal.
- Check if the pipeline is entangled or blocked.
- Check if the hose is cracked or damaged.
- Check if the hose model and wall thickness are correct.
- Check if there is any abnormal sound at the pump head and whether the roller

is rotating.

If the pump screen is on and there are no alarms, but the normal operating parameters are not working:

- Check the external remote control start and stop function settings.
- Check whether the current operation mode is analog speed regulation operation state.
- If it is allocation mode, enter the allocation parameter setting interface to check whether the parameters are correct.

10. Maintenance

- Check the running status of machine before starting it, normal operation can be put into use.
- Check for leakage, and correct fault which can be appeared.
- Clean liquid overflowed from the pump in time.
- The foot pedal switch and other external control plugs must be connected or disconnected in the power-off status to prevent the external control interface from being burned.
- The user's power socket must have ground wire, and have reliable grounding.
- This product does not have special certification such as medical certification. When it needs to be used in special fields such as medical and military, please self-certify.
- If the pump does not use for a long time, please clean it and keep it in dry and ventilated environment.
- The shell protection level of this product is IP66, and it is prohibited to operate underwater.
- The company shall not bear the direct and indirect losses caused by the malfunction or improper operation of this product.
- HPM series peristaltic pumps are splash-proof, water-resistant and dust-proof. Splash-proof, water-proof, and dust-proof functions are not permanently effective, and the protective performance may decrease due to daily wear and

tear. See owner's manual for cleaning and drying instructions. Damage caused by immersion in liquid is not covered by the warranty.

11. Warranty and After-sales Service

We support 5 years warranty for the pumps, subject to the exceptions below. Our company shall not be liable for any loss, damage, or expense directly or indirectly related to or arising out of the improper use of its products. This warranty does not obligate our company to bear any costs of removal, installation, transportation, or other charges which may arise in connection with a warranty claim.

If the pump fails during the warranty period, after confirmation by our technical department, we will provide spare parts free of charge. Customers will need to bear the shipping cost.

Exceptions:

- The warranty shall not apply to repairs or service necessitated by normal wear and tear or for lack of reasonable and proper maintenance.
- All tubing and pumping accessories as consumable items are excluded.
- Electrical surge as a cause of failure is excluded.
- Chemical attack is excluded.
- Improper operation or man-made damage as a cause of failure is excluded.

Innofluid Co., Ltd.

Add: Building 10, No. 860, Xinyang Road, Lingang New Area, Pilot Free Trade Zone, Shanghai, China.

Manufacturer: Baoding Shenchen Precision Pump Co., Ltd.

Tel: 0086-312-5958380

Fax: 0086-312-6780636

Website: www.innofluid.com

Email: info@innofluid.com

MADE IN CHINA