

# L100-1S-1/L100-1S-2 Operating Manual

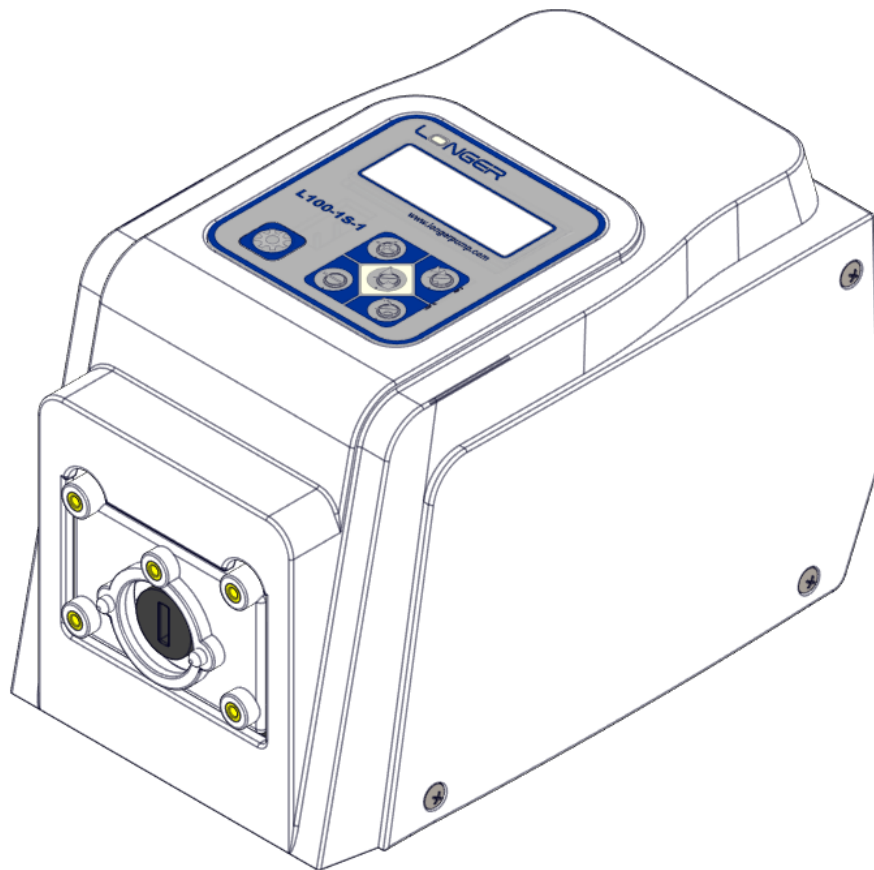

## Content

1	General Information.....	4
1.1	Precaution .....	4
1.2	Warranty and Service .....	4
1.2.1	Warranty Service.....	4
1.2.2	Maintenance Service.....	5
1.2.3	Service Commitment .....	5
1.2.4	Dispute Settlement .....	5
1.3	Repair Notes.....	5
1.4	Contacts Information.....	5
2	Product Introduction .....	6
2.1	Main Features of L100-1S-1/L100-1S-2.....	6
2.2	Unpacking.....	6
2.3	System Structure .....	6
2.3.1	Peristaltic Pump Drive .....	7
2.3.2	Applicable Pump Head and Tubing, and Reference Flow Rate .....	7
2.4	Function & Specification .....	9
2.4.1	Main Functions.....	9
2.4.2	Main Specification .....	9
3	System Installation .....	10
3.1	Outline Dimension of L100-1S-1/L100-1S-2.....	10
3.2	Installation of Pump Head.....	11
3.2.1	YZ1515x/YZ2515x/YZII15/YZII25 Installation .....	11
3.2.2	FG15-13/FG25-13 Installation .....	11
3.2.3	DMD15-13 Installation and Tubing Loading.....	12
3.2.4	DG Series Installation.....	13
3.2.5	DG15-24/DG15-28/DG15-48 Installation .....	13
3.2.6	BZ Series Installation .....	14
4	Operation .....	14
4.1	Keypad and LCD .....	14

---

4.2 Basic Operation (Introduction about the keypad function) .....	15
4.3 Run Screen.....	16
4.4 Control Mode Introduction and Mode Switch.....	17
4.5 Parameter Setting.....	19
4.5.1 Set the Parameters in Keypad Control Mode.....	19
4.5.1.1 Display Speed or Flow Rate .....	21
4.5.1.2 Pump State When Power On .....	21
4.5.1.3 Automatic Keypad Lock .....	21
4.5.1.4 Timing Work Mode.....	22
4.5.2 Set the Parameters in External Signal Control Mode.....	22
4.5.2.1 Set the Type of Speed Signal .....	23
4.5.2.2 Set the Max Speed .....	24
4.5.2.3 Set the Trigger Mode of Start/Stop Control .....	24
4.5.2.4 Set the Trigger Mode of Running Direction Control .....	24
4.5.3 Set the Communication Parameters through Keypad .....	25
4.6 Flow Rate Calibration.....	26
4.7 Reset to Factory Defaults .....	29
4.8 L100-1S-2 External Signal Control.....	29
4.8.1 Definition of External Control Port .....	29
4.8.2 Steps for External Signal Control.....	30
4.9 L100-1S-2 Communication Control.....	31
4.9.1 Communication Control Using Longer OEM Protocol .....	31
4.9.2 Communication Control Using Modbus RTU Protocol .....	31
Appendix 1 Longer OEM Protocol .....	32
Appendix 2 Modbus RTU Protocol .....	35
Appendix 3 Error code.....	37
Appendix 4 Factory Defaults .....	38
Appendix 5 Conversion Relationship Between Flow Rate and Speed .....	39

## 1 General Information

### 1.1 Precaution

- If tubing leaks or bursts, fluid may spray from the tubing and pump head. Take reasonable practicable measures to ensure the operators' safety.
- Make sure fluid in the tubing has been drained out, no pressure in the pipeline and disconnect pump from mains power, while removing or replacing the tubing.
- Disconnect pump from the mains power before connecting the control signal wire.
- Do not touch the rotor while pump is running.
- Release the compression block when pump stop running for a long time to avoid tubing deformation caused by squeezing.
- Keep the rotor clean and dry to avoid tubing excessive wear and premature failure of pump head or drive.
- Please do not add the lubricating oil to the rotor by yourself, any improper operation could corrode the pump head housing or dislocate the tubing.
- Please do not disassemble, refit or maintain the product without permission, so as to avoid damage or injury caused to operator, machinery, buildings, or other property. Contact Longer distributors if any maintenance needed.
- Connect the power cord, external control signal cable or communication control cable correctly, and do not damage the plug.
- Ground the product reliably to improve the electromagnetic compatibility.
- The pump drive hosing can't resist organic solvent and corrosive liquid, please clean the liquid left on the surface in time.

### 1.2 Warranty and Service

#### 1.2.1 Warranty Service

(1) Longer, obligation under this warranty is limited to a period of one (1) year from the date of original purchase. Within the 1 year of warranty period, Longer will replace or repair any defective parts free of charge. This warranty doesn't cover consumable part (tubing).

(2) Warranty does not cover:

- The repair or exchange of the entire unit after the warranty period.
- Any damage or failure caused by improper installation, storage, maintenance or usage, not in compliance with operating manual.
- Beyond or violate the conditions listed in contract or technical agreement.
- Any damage or failure caused by attempts by personnel other than authorized Longer representatives to install, repair, modify or remove the product.
- Any damage or failure caused by non-Longer parts, or user-replaceable parts purchased from unauthorized distributors.
- Any damage or failure caused by accidents or human errors (including wrong

power supply voltage, corrosion, fall-off, etc.)

- Any damage or failure caused by natural disaster or other irresistible force (earthquake, fire, etc.).
- Other product damage or failure not caused by defects in design, material and workmanship.

### **1.2.2 Maintenance Service**

- Customer will be charged for the repair or replacement of the parts or accessories after warranty period.
- Parts can be replaced within 3 working days. Longer will inform customer of the date in advance if out of 3 working days.

### **1.2.3 Service Commitment**

- Longer commits to provide customer solutions to any quality complaint within 2 working days.
- Longer commits to reply to customer's requirement of on-site technical supports or training within 2 working days.

### **1.2.4 Dispute Settlement**

Dispute over product quality or service will be handled according to contract or agreement. If there is no related contract or agreement, it shall be resolved by the disputing parties through consultation. Otherwise, it will be resolved according to relevant national laws and regulations.

## **1.3 Repair Notes**

Please contact Longer or its distributor, and provide the product serial number before returning the product. Products which has been contaminated with, or exposed to, toxic chemicals or any other substance hazardous to health must be decontaminated before returning to Longer or its distributor. You must ship the product in its original packaging or better, to insure it against possible damage or loss during the transport.

## **1.4 Contacts Information**

Longer Precision Pump Co., Ltd  
Building A, Chuangye Center, Baoding National High-Tech Industry Development Zone  
Baoding, Hebei, China 071051  
Email: [longer@longerpump.com](mailto:longer@longerpump.com)  
Tel: 86-312-3110087  
Fax: 86-312-3168553  
[www.longerpump.com](http://www.longerpump.com)

## 2 Product Introduction

### 2.1 Main Features of L100-1S-1/L100-1S-2

L100-1S-1 and L100-1S-2 are mainly designed for laboratory and light industry applications. The LCD screen could display flow rate or speed, and flow rate calibration function could improve the flow rate accuracy. The pump drives can be fitted with several different pump heads, and the max flow rate is 500mL/min. With optimized hardware and software design, the pumps have good EMC and could operate stably and reliably. With precise speed control in increments of 0.01rpm (10000:1 turndown ratio), the pumps have more accurate and wider range of flow rate. Simple timing function can stop the pump automatically according to the set time. L100-1S-1 can be controlled through keypad, and L100-1S-2 can be controlled through keypad, external control signal or communication commands.

### 2.2 Unpacking

To unpack the pump, follow below steps:

- 1) Take out the pump and the accessories from the shipping carton.
- 2) Check the packing list, confirm all components are present and in good order.
- 3) In case of any question, please contact Longer or the local distributor.

### 2.3 System Structure

Peristaltic pump includes the following parts:

- ① Peristaltic pump drive L100-1S-1 or L100-1S-2
- ② Pump head + tubing

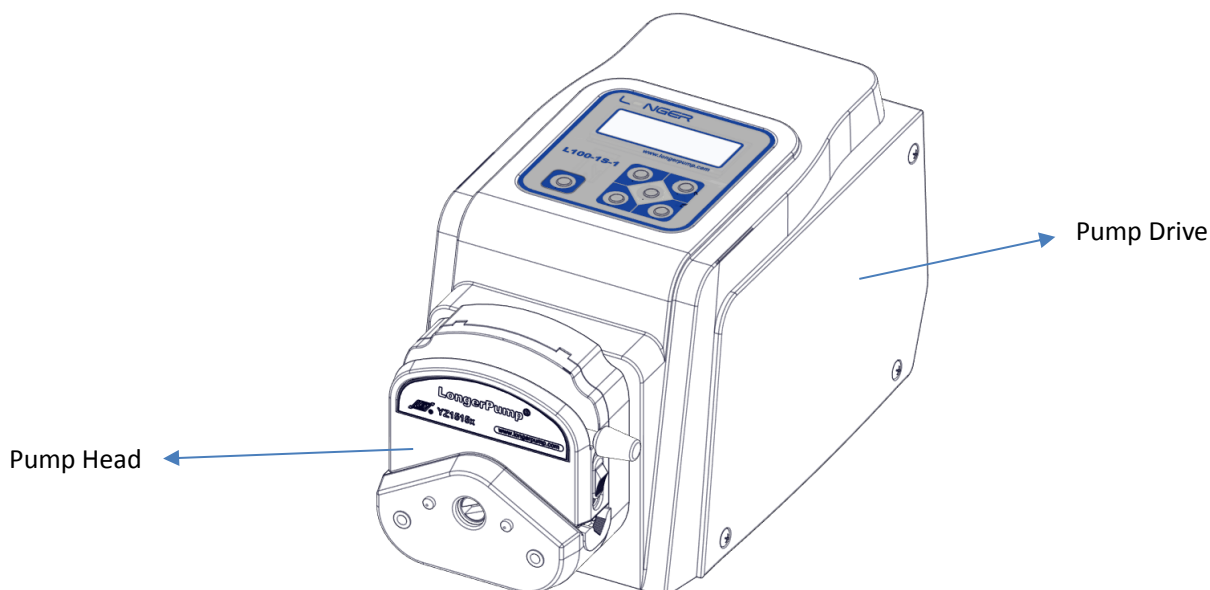

### 2.3.1 Peristaltic Pump Drive

The pump drive is used to rotate the rotor assembly inside the pump head, to squeeze and release the tubing for fluid delivery.

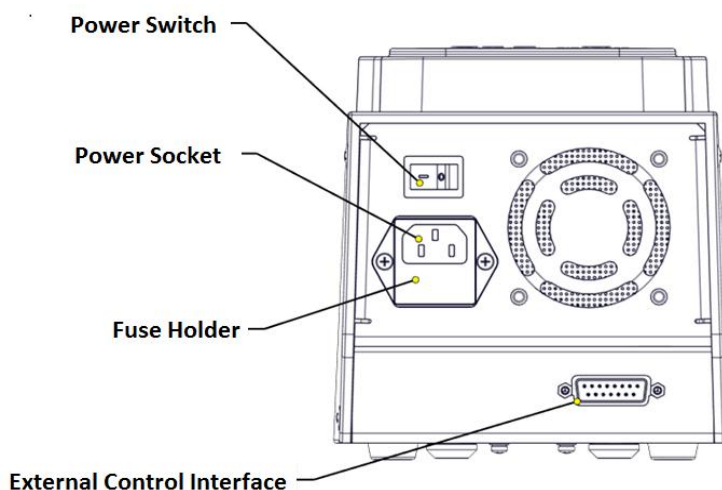
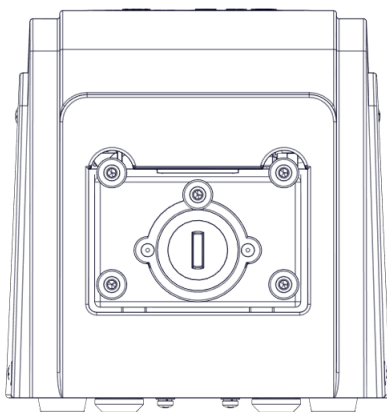

### 2.3.2 Applicable Pump Head and Tubing, and Reference Flow Rate

The pump head and tubing are used to transfer the fluid. Please refer to below table for the applicable pump heads and tubings.

Pump Head	Applicable Silicone Tubing	Applicable Pharmed Tubing	Reference Flow Rate (silicone tubing) mL/min
YZ1515X, YZ II 15	13#, 14#, 19#, 16#, 25#, 17#, 18#		380
FG15-13	13#, 14#, 19#, 16#, 25#, 17#, 18#	13#, 14#, 19#, 16#	430
DMD15-13-B/D	2*13#, 2*14#, 2*19#, 2*16#, 2*25#	2*13#, 2*14#, 2*19#, 2*16#	375
YZ II 25	15#, 24#, 35#, 36#	Not recommended	500
YZ2515X	15#, 24#	Not recommended	270
FG25	15#, 24#	Not recommended	320
BZ15-13-A	14#	14#	22
BZ15-13-B	16#	16#	80
BZ15-13-C	25#	25#	150
BZ15-13-D	17#	Not recommended	270
BZ25-13	24#	Not recommended	250
DG15-28	13#, 14# ID≤3.17mm Wall thickness: 0.8-1mm	Not recommended	75 (single channel)
DG15-24	16#, 25#, 17#	Not recommended	300 (single channel)
DG-(1, 2)6 rollers	ID≤3.17mm Wall thickness: 0.8-1mm	ID≤3.17mm Wall thickness: 0.8-1mm	48 (single channel)
DG-(4, 6, 8)6 rollers	ID≤3.17mm Wall thickness: 0.8-1mm	Not recommended	48 (single channel)
DG-(1, 2)10 rollers	ID≤3.17mm Wall thickness: 0.8-1mm	ID≤3.17mm Wall thickness: 0.8-1mm	32 (single channel)
DG-4 10 rollers	ID≤3.17mm Wall thickness: 0.8-1mm	Not recommended	32 (single channel)

Note: The flow rate in above table is only for the reference, which were tested at the indoor temperature with water. When select pump head and tubing, the decay of flow and the fluid viscosity need to be considered.



## 2.4 Function & Specification

### 2.4.1 Main Functions

- Applicable pump heads: YZ1515X, YZ1115, FG15, BZ15, DMD15, DG15-24, DG15-28, YZ2515X, YZ1125, FG25, BZ25, DG-1, DG-2, DG-4, DG-6, DG-8.
- Work mode: continuous transfer mode and simple timing mode
- Flow rate display and calibration: LCD could display current flow rate, and the calibration function improves the flow rate accuracy.
- Simple timing: the pump could stop automatically when the time is up.
- Control mode:
  - L100-1S-1: keypad control mode
  - L100-1S-2: keypad control mode, external signal control mode, communication control mode
- L100-1S-2 external signal control: speed control signal (4-20mA /0-5V /0-10V /0-10kHz signals are optional with uniform interface, and the max speed can be set). Start/stop control signal and running direction control signal are switch signal, the trigger mode could be set as level (momentary) or pulse (maintained)
- L100-1S-2 communication control: RS485 interface, compatible with both Longer protocol and Modbus RTU protocol, and the protocol could be identified automatically.
- Prime function: fast filling or emptying at full speed.
- Display function: LCD displays all control information, pump state and set parameters
- Keypad lock function: keypad can be locked to prevent the misoperation.
- Memory function: the state and parameters will be saved automatically, and could be used directly when power on.
- Pump state when power up: could be set as stop or run.

### 2.4.2 Main Specification

- Max flow rate: 500mL/min
- Speed: 0.01-100rpm
- Speed resolution:
  - In increments of 0.01rpm within 0.01rpm-10rpm
  - In increments of 0.1rpm within 10rpm-100rpm
- External control signal: switch signal for external start/stop control and direction control, 0-5V/0-10V/4-20Ma/0-10KHz for external speed control,
- Communication interface: RS485
- Communication protocol: Longer protocol or Modbus RTU protocol
- EMC: Comply with EMC Directive 2014/30/EU
- Keypad lock: the delay time before lock can be set as 30s/1min/3min/5min/8min/9min59s, the keypad lock function defaults as disabled.
- Timing option: the time can be set as 30s/1min/2min/3min/4min/5min/6min/7min/8min/9min/10min/20min/30min, the timing function defaults as disabled.

- Power supply: AC100-240V 50Hz/60Hz
- Consumption power: <25W
- Working condition: temperature:0-40℃, relatively humidity: <80%
- Outline dimension(LxWxH): 232\*142\*150(mm)
- Weight: 2.4kg
- IP rating: IP31

### 3 System Installation

The pump needs to be correctly assembled before use

#### 3.1 Outline Dimension of L100-1S-1/L100-1S-2

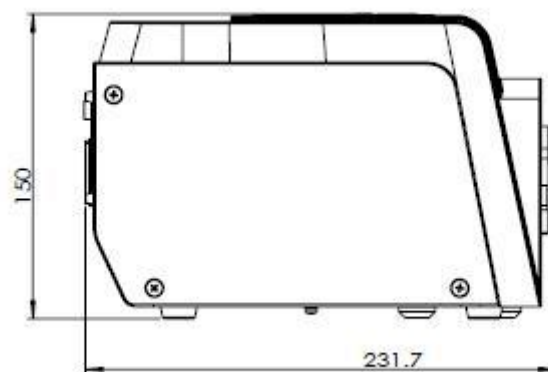
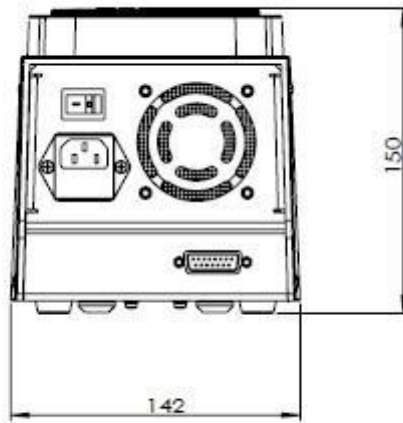

## 3.2 Installation of Pump Head

### 3.2.1 YZ1515x/YZ2515x/YZII15/YZII25 Installation

Insert the tang of the pump head shaft into the slot of the black rubber coupling, and insert the alignment pin of the drive unit into the alignment hole on the back of the pump head, then tighten the mounting screws.

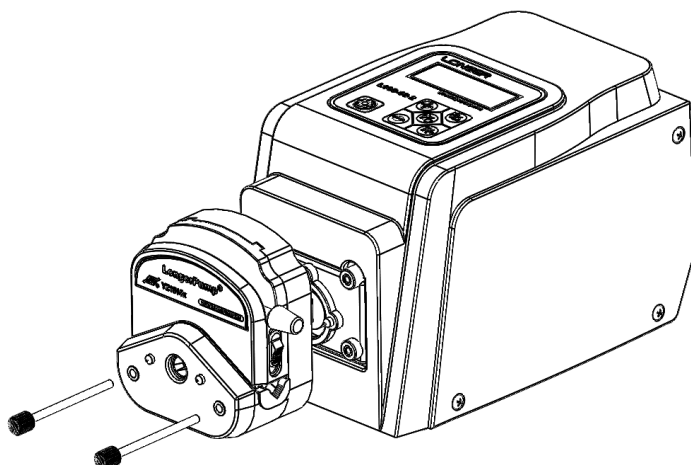

### 3.2.2 FG15-13/FG25-13 Installation

#### Mounting the pump head:

Mount the mounting plate on the drive unit through tightening three mounting screws M4X10. Insert the tang of the pump head shaft into the slot of the black rubber coupling, turn the pump head 45 degree relative to the vertical direction, engage the bayonet on the mounting plate with the bayonet slot on the back of the pump head, turn the pump head clockwise until it locks into an upright position.

#### Remove the pump head:

Push the locking lever back and turn the pump head anti-clockwise about 45 degree. Then take off the pump head from the mounting plate.

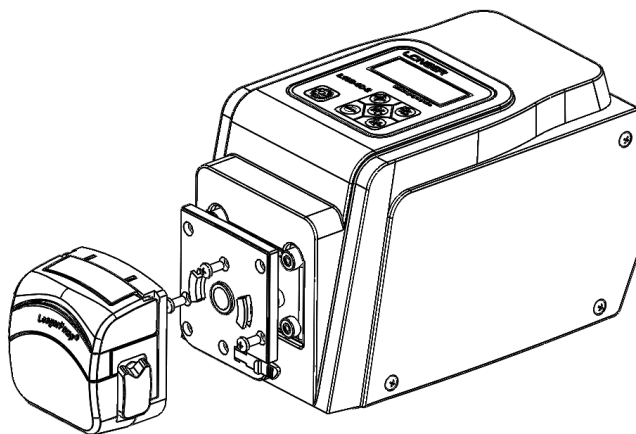

### 3.2.3 DMD15-13 Installation and Tubing Loading

#### Pump Head Mounting:

Mount the mounting plate on the drive unit through three cross recess head screws M4X10. Release the two levers to open the pump head and remove the compression block. Insert the tang of the pump head shaft into the slot of the black rubber coupling. Press the pump head firmly against the mounting plate. Turn the pump head to align the mounting holes on the pump head with the mounting holes on the mounting plate. Insert the two mounting screws (hexagon socket head cap screw M3X8) into the mounting holes, then tighten them.

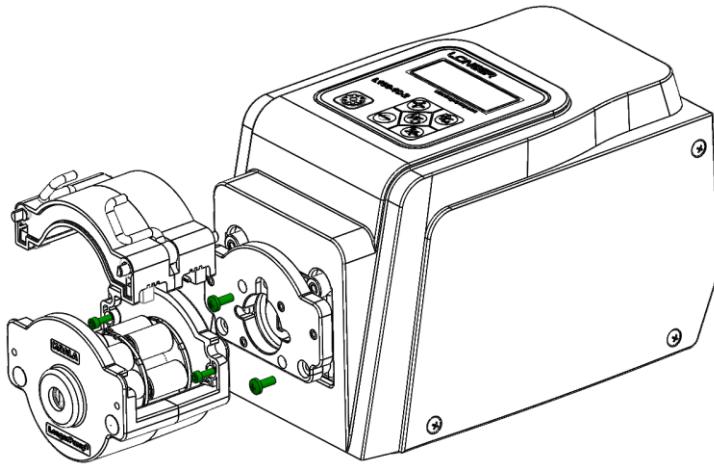

#### Tubing Loading:

Release the levers to remove the compression block. Insert the tubing fitting assembly into the compression block.

Note: When use 25# tubing, the partition block needs to be fixed at the outermost positioning hole.

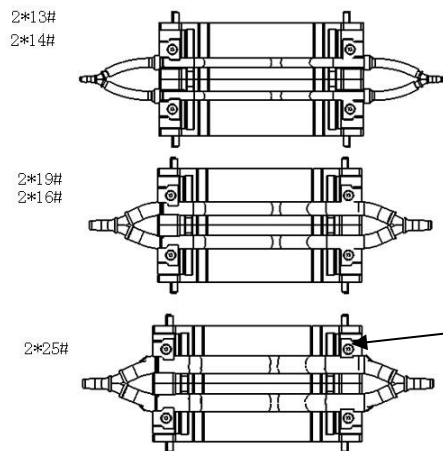

The four partition blocks need to be fixed at the outermost positioning holes

Put the compression block with tubing fitting assembly back to the pump head, and lock the levers.

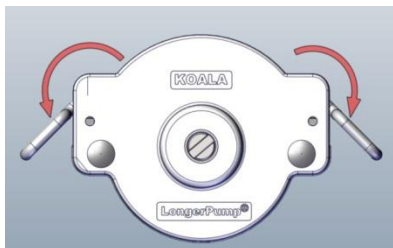

### 3.2.4 DG Series Installation

Remove the tubing and the pump head cartridges. Insert the tang of the pump head shaft into the slot of the black rubber coupling. Press the pump head firmly against the pump drive. Turn the pump head to align the mounting holes on the pump head with the mounting holes on the pump drive. Insert the 2 hexagon socket head cap screws M4X8, then tighten them.

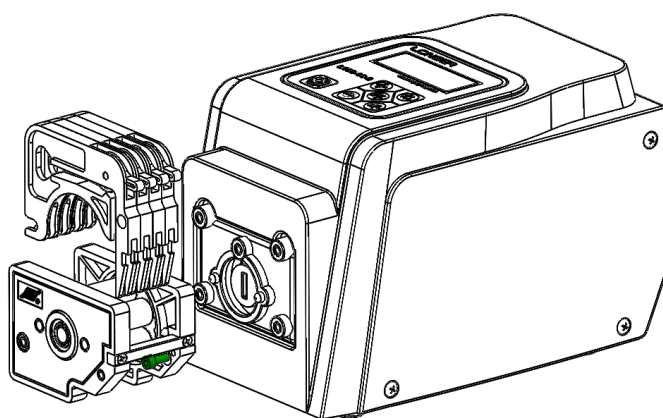

### 3.2.5 DG15-24/DG15-28/DG15-48 Installation

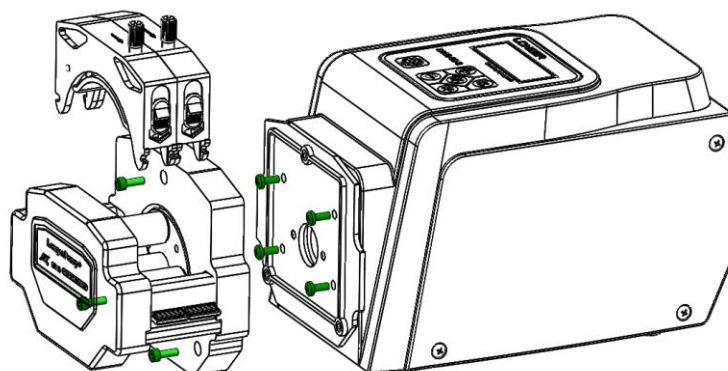

Mount the mounting plate on the drive unit through four screws M4X10. Remove the tubing and the pump head cartridges. Insert the tang of the pump head shaft into the slot of the black rubber coupling. Press the pump head firmly against the pump drive. Turn the pump head to align the mounting holes on the pump head with the mounting holes on the pump drive. Insert the 3 screws M4X16, then tighten them.

### 3.2.6 BZ Series Installation

Insert the tang of the pump head shaft into the slot of the black rubber coupling. Press the pump head firmly against the pump drive. Turn the pump head to align the mounting holes on the pump head with the mounting holes on the pump drive. Insert the 4 mounting screws into the mounting holes, then tighten them.

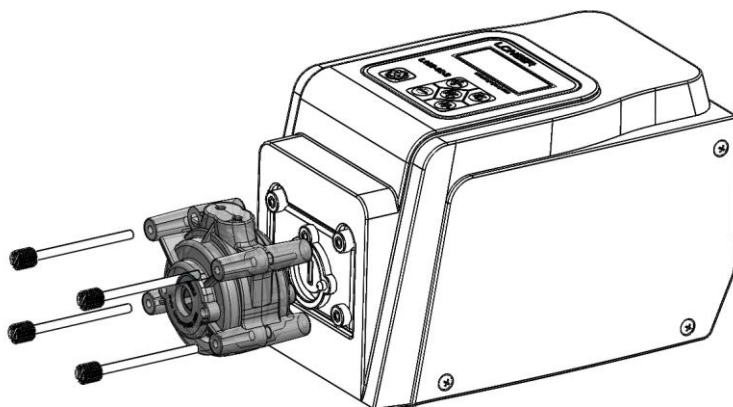



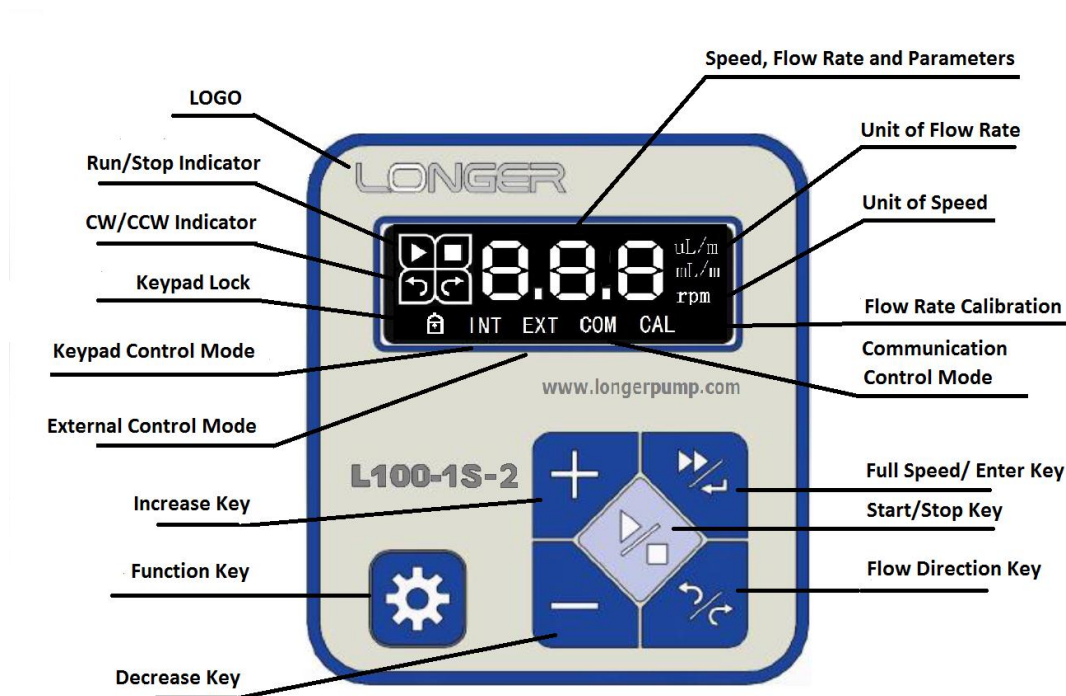

## 4 Operation

### 4.1 Keypad and LCD







Instruction of displayed information

1. Factory Defaults:
  - a. Control mode is keypad control mode
  - b. The running state is stop.

- c. The running direction is CW
- d. Speed is 100rpm
2. When the pump is in the keypad control mode, tap Start/Stop Key to start or stop the pump. and LCD will display  for running, and  for stop.
3. When the pump is in the keypad control mode, tap Direction Key to change the pump running direction, and LCD will display  for clockwise direction, and  for counter clockwise direction.
4. When the pump is in the keypad control mode, tap Increase Key or Direction Key to change pump speed in increments of 0.1rpm when the pump speed is higher than 10rpm, or in increments of 0.01 rpm when the pump speed is lower than 10 rpm. The increments increase progressively as long as the Increase Key or Decrease Key is continually held down.

## 4.2 Basic Operation (Introduction about the keypad function)

Keypad	Name	Single Tap	Continually Hold Down	Remarks
	Flow Direction Key	<ul style="list-style-type: none"> <li>● <b>In the keypad control mode:</b> tap the key to toggle the fluid transfer direction</li> </ul>	N/A	The key is invalid in the external signal control mode and communication control mode.
	Full Speed/Enter Key	<ul style="list-style-type: none"> <li>● <b>In the flow rate calibration function:</b> tap the key to exit the calibration function when E04 error code displays on the screen.</li> </ul>	<ul style="list-style-type: none"> <li>● <b>In the keypad control mode:</b> when the LCD displays the Run Screen, press and hold the key to operate the pump at full speed, then LCD displays [--], to finish the operations of emptying, filling and rinsing; Release the key to return to the previous operating state.</li> </ul>	The key is invalid in the external signal control mode and communication control mode.
	"+/-"Key	<ul style="list-style-type: none"> <li>● <b>Set the speed or flow rate:</b> Tap the Key "+" or "-" to increase or decrease the rightmost digit in increments of 1.</li> <li>● <b>Select the parameter option:</b> when LCD display the parameter setting screen, tap the Key "+" or "-" to switch the options.</li> </ul>	<ul style="list-style-type: none"> <li>● <b>Set the speed or flow rate:</b> press and hold the Key "+" or "-" to continuously increase or decrease the second digit from the right in increments of 1. When the holding time is more than 5s, the leftmost digit will be increased or decreased in increments of 1.</li> </ul>	The key is invalid in the external signal control mode and communication control mode.

	<p>Start/ Stop Key</p>	<ul style="list-style-type: none"> <li>● <b>In the keypad control mode:</b> tap the key to start or stop the pump.</li> <li>● <b>In the flow rate calibration function:</b> tap the key to start or stop the testing pumping.</li> </ul>	<p>N/A</p>	<p>The key is invalid in the external signal control mode and communication control mode.</p>
	<p>Function Key</p>	<ul style="list-style-type: none"> <li>● <b>In running screen:</b> L100-1S-2: tap the key to toggle the three control modes and flow rate calibration function. L100-1S-1: tap the key to toggle the keypad control mode and flow rate calibration function.</li> <li>● <b>In parameter setting screen:</b> tap the key to save the parameter setting and enter next parameter setting screen.</li> </ul>	<ul style="list-style-type: none"> <li>● <b>In running screen:</b> press and hold the key to enter the parameter setting screen.</li> </ul>	<p>N/A</p>

### 4.3 Run Screen

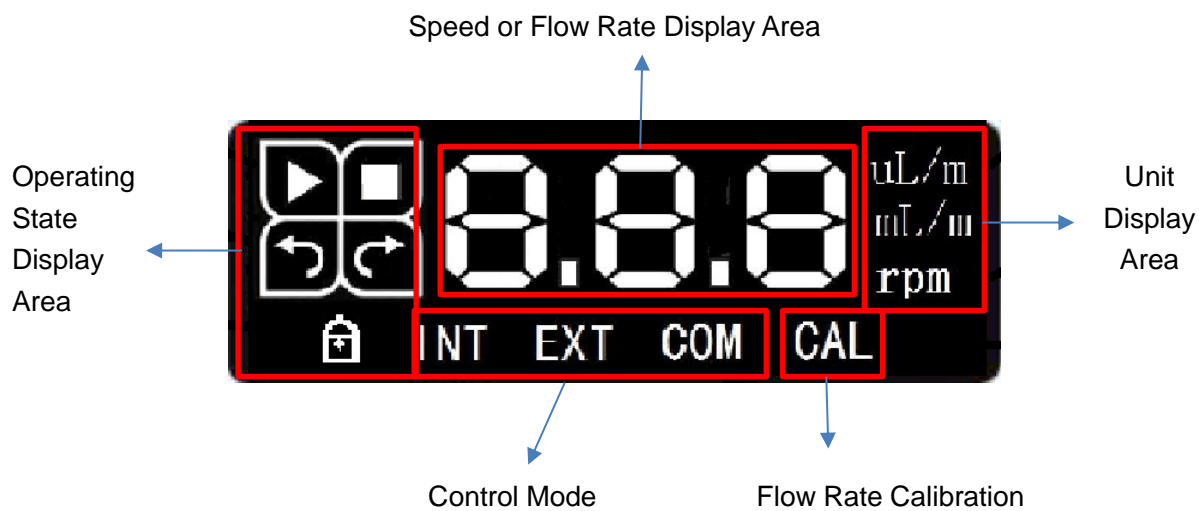

#### Run Screen Introduction:

- a. Operating state display area: displays the running state, the flow direction and keypad lock. “▶” and “◻” indicate the running and stop state of the pump respectively. When the pump is running, the indicator light ▶ will be on; when it stops, the indicator light ◻ will be on. “◀” and “▶” indicate the flow direction of



the pump. When the pump is running clockwise, the indicator light  will be on;

when it is running anti-clockwise, the indicator light  will be on. When the keypad

is locked, the indicator light  will be on.

- b. Speed or flow rate display area: displays the set speed or flow rate.
- c. Unit display area: displays the unit of the parameter in the main area. "rpm" indicates current parameter is pump speed. "uL/min", "mL/m" or "L/m" indicates current parameter is flow rate.
- d. Control mode area: L100-1S-1 only has keypad control mode and "INT" displayed in this area. L100-1S-2 has three control modes: "INT" means keypad control mode, "EXT" means external signal control mode, "COM" means communication control mode.
- e. "CAL" means flow rate calibration function. When "CAL" is highlighted, the flow rate could be calibrated.

#### 4.4 Control Mode Introduction and Mode Switch

L100-1S-2 has three control modes: keypad control mode, screen displays "INT"; external signal control mode, screen displays "EXT"; communication control mode, screen displays "COM". L100-1S-1 only has keypad control mode, and screen displays "INT". The control modes and flow rate calibration function can be switched over by tapping Function Key



##### 1. Keypad Control Mode [INT]:

If the pump is going to be controlled through the keypad, the control mode needs to be set as "INT" firstly. Then the start/ stop state, running direction, speed or flow rate can be directly controlled through the keypad.



In the keypad control mode, press and hold the Function Key  to enter the parameter setting screen. Following parameters can be set: pump displays speed or flow rate, pump state when power up (stop or run), automatic keypad lock, simple timing work mode. Refer to Chapter 4.5.1 for parameter setting details.

##### 2. External Signal Control Mode [EXT]:

If L100-1S-2 is going to be controlled by external signals, the control mode needs to be set as "EXT" firstly. Then the start/ stop state, running direction, speed (or the equivalent in flow rate if the pump has been configured to display flow rate) can be directly controlled through the remote signals.



In the external signal control mode, press and hold the Function Key  to enter the parameter setting screen. Following parameters can be set: type of speed signal can be set as 4-20mA, 0-5V, 0-10V or 0-10kHz, the maximum speed corresponding to max signal, the start/stop control trigger mode, and the running direction control trigger mode. Refer to Chapter 4.5.2 for parameter setting details.

**Note:**

- a. In the external signal control mode, the keypad control and communication control are invalid, but the Function Key is still functional.
- b. Following parameters set in keypad control mode are still valid in external signal control mode: pump displays speed or flow rate, automatic keypad lock.

**3. Communication control mode [COM]:**

If L100-1S-2 is going to be controlled by external computer or microprocessor through communication interface RS485, the control mode needs to be set as “COM” firstly. The pump is compatible with Longer OEM protocol and Modbus (RTU) protocol, and capable of automatic protocol identification. In the communication control mode, the computer can control the start/ stop, running direction and the speed or flow rate of the pump by sending the commands to pump.



In the communication control mode, press and hold the Function Key  to enter the parameter setting screen. Following parameters can be set: pump address, baud rate, parity and stop bit. Refer to Chapter 4.5.3 for parameter setting details.

**Note:**

- a. In the communication control mode, keypad control and external signal control are invalid, but the Function Key is still functional.
- b. Following parameters set in keypad control mode are still valid in external signal control mode: pump displays speed or flow rate, automatic keypad lock.

**4. Flow Rate Calibration Function [CAL]:**

if the pump has been configured to display flow rate, the flow rate needs to be calibrated after switching the pump on for the first time, and after changing the tubing, pump head



and fluid. Tap the Function Key  to highlight “CAL’, then press and hold the Function Key to enter the flow rate calibration screen. Refer to Chapter 4.6 for calibration operation detail.

## 4.5 Parameter Setting

### 4.5.1 Set the Parameters in Keypad Control Mode

In keypad control mode, following parameters can be set: pump displays speed or flow rate, pump state when power on (stop or run), automatic keypad lock and simple timing work mode. The settings of displaying speed or flow rate and automatic keypad lock are still valid in external signal control mode and communication control mode.

Parameter setting procedure:



Tap the Function Key  to set the control mode as keypad control mode “INT”, then



the pump displays the running screen . Press and hold the Function



Key to enter the parameter setting screen . Tap the Function Key to select parameter, tap “+” and “-” to set the parameter, then tap the Function Key to save the setting and enter next parameter setting screen, until the last parameter is set and return to keypad control mode running screen.

**Note:** the Function Key is only valid when the pump stops.

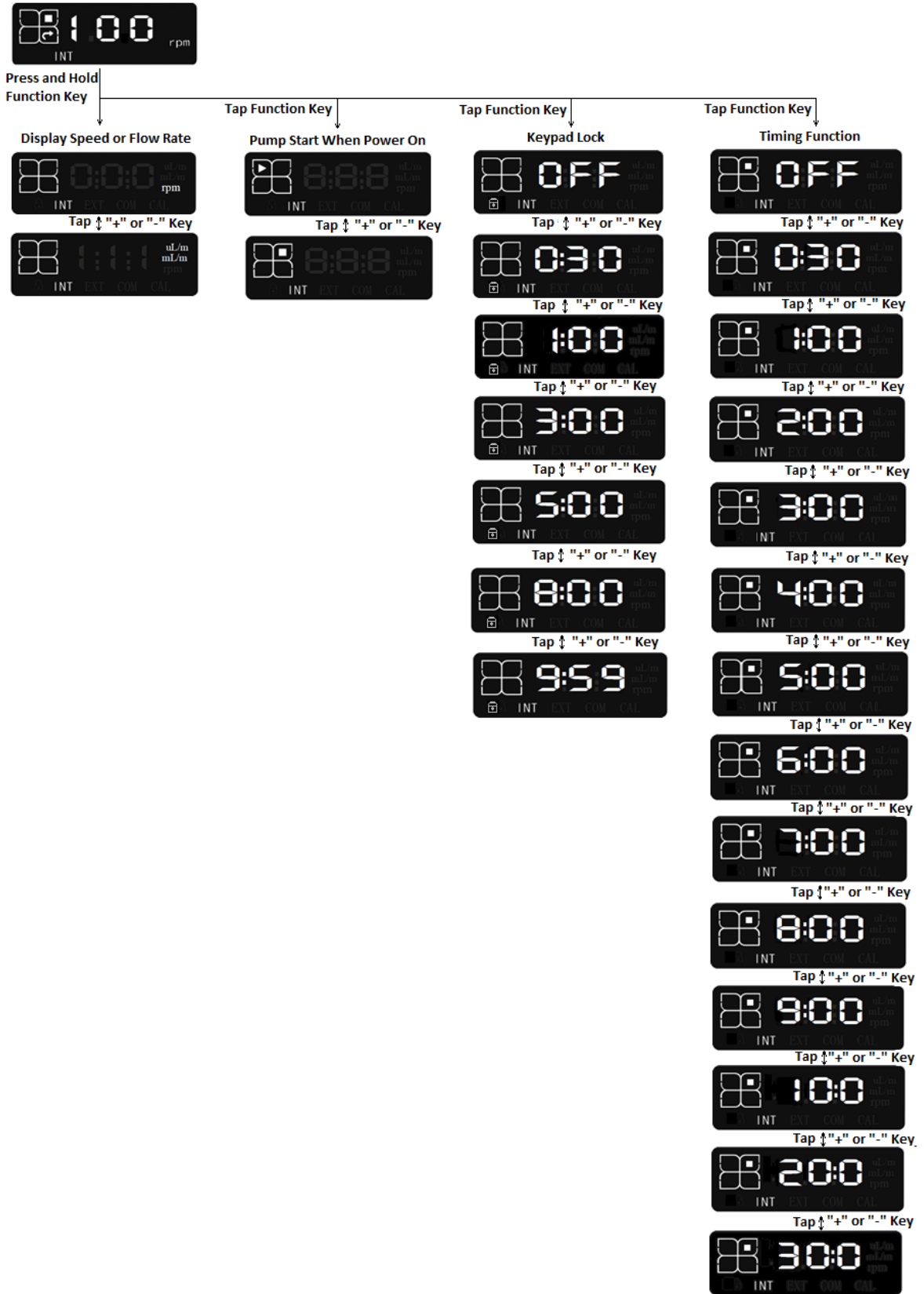

#### 4.5.1.1 Display Speed or Flow Rate

Setting the parameter unit to define the type of displayed parameter as speed or flow rate. “rpm” means speed, “uL/min” or “mL/min” means flow rate.



When the pump stops, tap the Function Key  to set the control mode as the keypad control mode “INT”. Press and hold the Function Key to enter the parameter setting screen, then the LCD displays the parameter unit setting screen



, tap “+” or “-” key to set the unit. Then tap Function Key to save the setting and enter the setting screen of pump state when power on



**Note:** if the pump has not been calibrated since it was shipped out from factory, the default conversion relationship between flow rate and speed is flow rate (mL/min)= speed (rpm) \*1 (refer to Appendix 5 for the relationship between flow rate and speed). After calibration, the conversion relationship between the speed and flow rate will be based on the most recent calibration result.

**Note:** when the pump is running in the keypad control mode, the shortcut to toggling the display between speed and flow rate is tapping the Function Key.

#### 4.5.1.2 Pump State When Power On

The pump state when power on can be set as stop or run.



In the setting screen of pump state when power on , when  is highlighted, the pump will automatically run when power on. When  is highlighted, the pump will stop when power on.

Tap “+” or “-” key to set the state, then tap the Function Key to save the setting and enter the setting screen of automatic keypad lock.

#### 4.5.1.3 Automatic Keypad Lock

The keypad lock function can be used to lock the keypad when the keypad is idle. The delay time between the beginning idle and locking can be set, so as to prevent any misoperation.

The delay time between the beginning idle and locking can be set as: 30s/1min/3min/5min/8min/9min59s.



In the setting screen of automatic keypad lock , the factory default setting is not to lock automatically, and the LCD displays “OFF”. Tap “+” or “-” key to enable the automatic keypad lock function and set the lock delay time. Tap Function Key to save the setting and enter the timing work mode setting screen.

**Note:** When the keypad is locked,  will be highlighted. Press and hold the

Function Key  for more than 3 seconds, the keypad will be unlocked.

#### 4.5.1.4 Timing Work Mode

In the keypad control mode, there are two work modes: continuous transfer mode and simple timing mode. In the continuous transfer mode, start or stop the pump by tapping Start/Stop Key. In the simple timing mode, after starting the pump by tapping Start/Stop Key, the pump will record the elapsed time and stop automatically when time is up. The timing can be set as: 30 seconds, 1 minute, 2 minutes, 3 minutes, 4 minutes, 5 minutes, 6 minutes, 7 minutes, 8 minutes, 9 minutes, 10 minutes, 20 minutes, 30 minutes.



In the timing work mode setting screen , the factory default setting is continuous transfer mode (timing work mode is disabled) and the LCD displays “OFF”. Tap “+” or “-” key to enable the timing work mode and set the time. Then tap the Function Key to save the setting and return to the keypad control mode running screen.

#### 4.5.2 Set the Parameters in External Signal Control Mode

When L100-1S-2 is configured as external signal control mode, following parameters can be set: type of speed signal (can be set as 4-20mA, 0-5V, 0-10V or 0-10kHz), the maximum speed corresponding to maximum signal, the trigger mode of start/stop control, and the trigger mode of running direction control.

Parameter Setting Procedure:



Tap the Function Key  to set the control mode as external signal control mode

“EXT”, then the pump displays the running screen . Press and hold

the Function Key to enter the parameter setting screen . Tap the

Function Key to select parameter, and tap “+” and “-” to set the parameter, then tap the Function Key to save the setting and enter next parameter setting screen, until the last parameter is set and return to external signal control mode running screen.

**Note:** the Function Key is only valid when the pump stops.

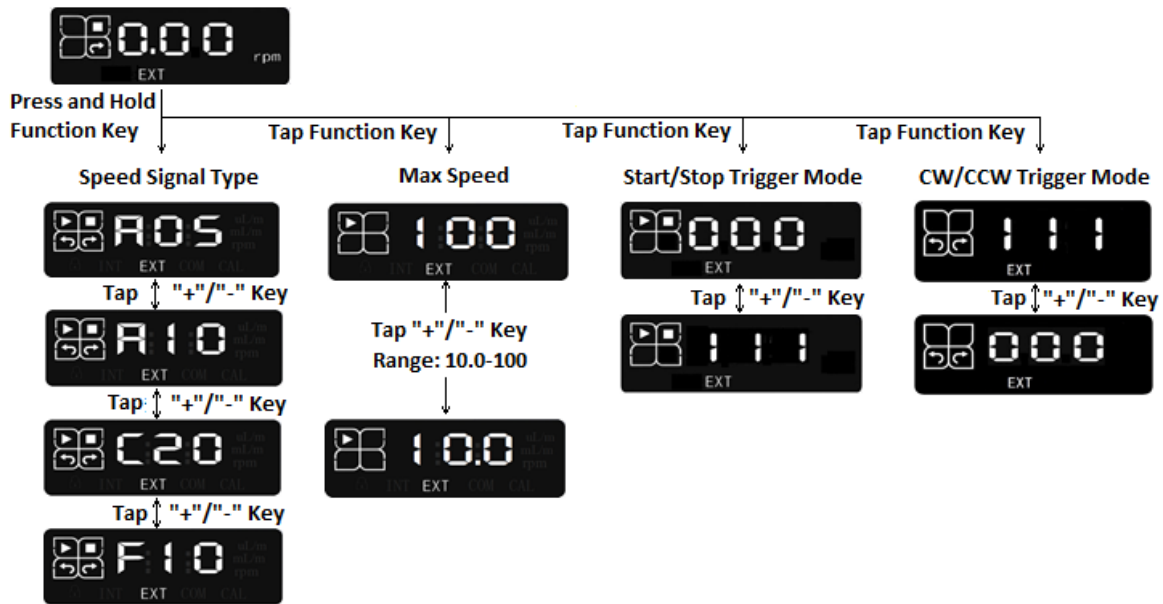

#### 4.5.2.1 Set the Type of Speed Signal

When L100-1S-2 is configured as external signal control mode, the pump could accept speed signal from PLC or other controllers. 4 types of speed signal are acceptable: 0-5V signal (option: A05), 0-10V signal (option: A10), 4-20mA signal (option: C20), 0-10kHz signal (option: F10).



Tap the Function Key to set the control mode as external control mode “EXT”,



then the pump displays the running screen. Press and hold the



Function Key to enter the setting screen of speed signal type. Tap “+” or “-” key to set the speed signal type, then tap the Function Key to save the setting and enter the setting screen of max speed corresponding to max signal.

#### 4.5.2.2 Set the Max Speed

When L100-1S-2 is configured as external signal control mode, the max speed defaults to 100rpm. And the max speed could be set from 10.0rpm to 100rpm. For example, when the speed control signal is 0-5V, and the max speed is set as 50rpm. Then the speed range corresponding to 0-5V signal is 0-50 rpm, and the speed is in linear correlation with the signal.



In the setting screen of max speed , tap “+” or “-” key to set the max



speed. Then tap the Function Key to save the setting, and enter the setting screen of start/stop control trigger mode.

#### 4.5.2.3 Set the Trigger Mode of Start/Stop Control

The trigger mode of start/stop control can be set as level mode (momentary) or pulse mode (maintained). Control signal is switch signal. When the trigger mode is set as level mode (option: 111), the pump runs when the switch contact closed, and the pump stops when the switch contact open. When the trigger mode is set as pulse mode (option: 000), input pulse signal to toggle the pump between run and stop, and the switch contact changing from open to close is considered a valid pulse.



In the setting screen of start/stop control trigger mode , tap “+” or “-” to



set the trigger mode. Then tap the Function Key to save the setting, and enter the setting screen of running direction control trigger mode.

#### 4.5.2.4 Set the Trigger Mode of Running Direction Control

The trigger mode of running direction control can be set as level mode (momentary) or pulse mode (maintained). Control signal is switch signal. When the trigger mode is set as level mode (option: 111), the pump runs CW when the switch contact closed, and the pump runs CCW when the switch contact open. When the trigger mode is set as pulse mode (option: 000), input pulse signal to toggle the pump running direction between CW and CCW, and the switch contact changing from open to close is considered a valid pulse.



In the setting screen of running direction control trigger mode , tap





“+” or “-” to set the trigger mode. Then tap the Function Key  to save the setting, and return to the running screen of external control mode.

### 4.5.3 Set the Communication Parameters through Keypad

L100-1S-2 could be controlled remotely by computer through serial communication with RS485 interface. And the pump is compatible with both Longer protocol and Modbus RTU protocol, which could be identified automatically. Before sending the commands, the communication parameters could be set through keypad, including pump address, baud rate, parity and stop bit.

Setting options of each parameter:

Pump address: Modbus RTU protocol: address range: 1-32, options are A01-A32.

Longer OEM protocol: address range: 1-30, options are A01-A30.

Baud rate: 12 (1,200bps), 24 (2,400bps), 48 (4,800bps), 96 (9,600bps), 192 (19,200bps) and 384 (38,400bps)

Parity: P-n (no parity), P-O (odd parity) and P-E (even parity)

Stop bit: S-1 (1 stop bit) and S-2 (2 stop bits)

Parameter Setting Procedure:



Tap the Function Key  to set the control mode as communication control mode

“COM”, then the pump displays the running screen . Press and hold



the Function Key to enter the parameter setting screen . Tap the Function Key to select parameter, and tap “+” and “-” to set the parameter, then tap the Function Key to save the setting and enter next parameter setting screen, until the last parameter is set and return to running screen of communication control mode.



**Note:** the Function Key is only valid when the pump stops.

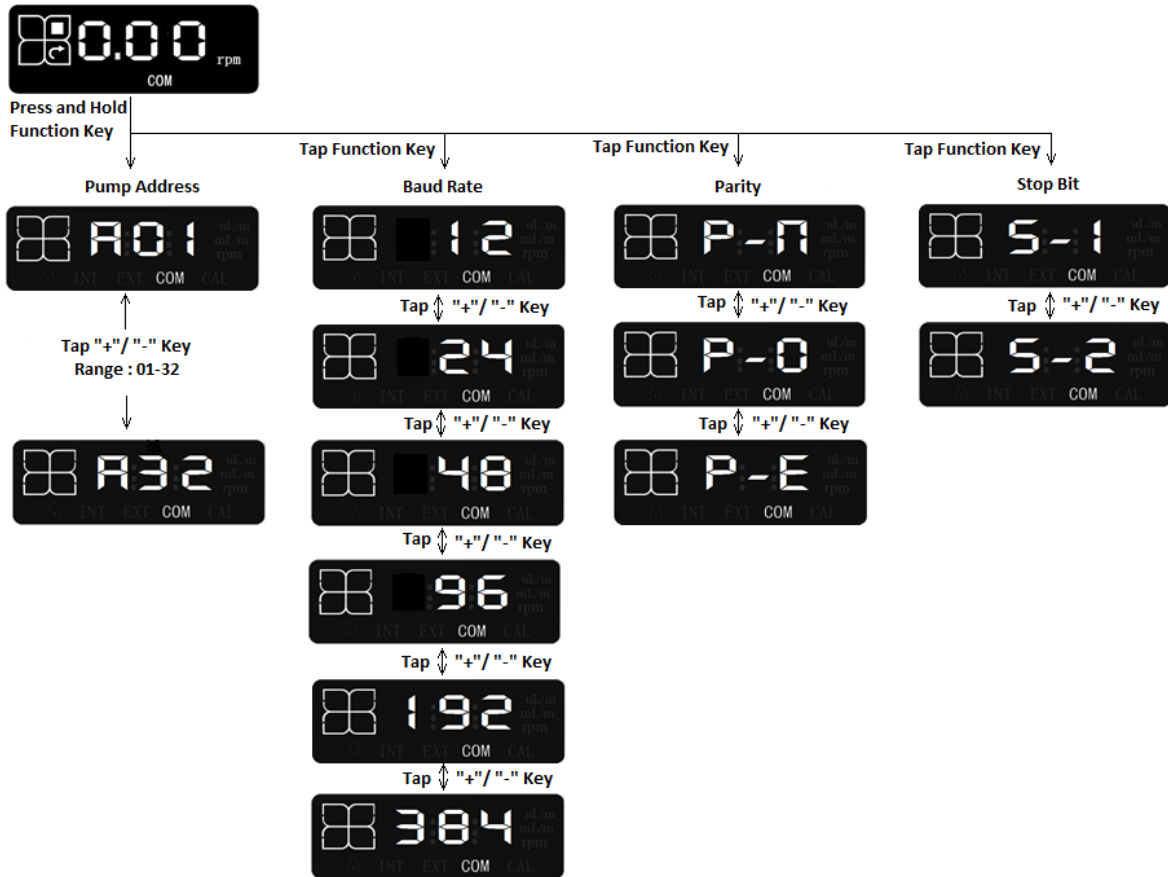

#### 4.6 Flow Rate Calibration

If the pump has been configured to display flow rate, the flow rate needs to be calibrated after switching the pump on for the first time, and after changing the tubing, pump head

and fluid. Tap the Function Key  to highlight "CAL" , then press and hold the Function Key to enter the flow rate calibration screen

. During the flow rate calibration process, set three parameters in order: pump speed for calibration, the actual volume and the volume unit. Tap "+" or "-" key to set the parameter, then tap the Function Key to save the setting and enter next parameter setting screen. After setting the volume unit, tap the Function Key to save the setting, then pump will calibrate the flow rate automatically, and will return to the flow rate

calibration function screen .

**Note:** the Function Key is only valid when pump stops.

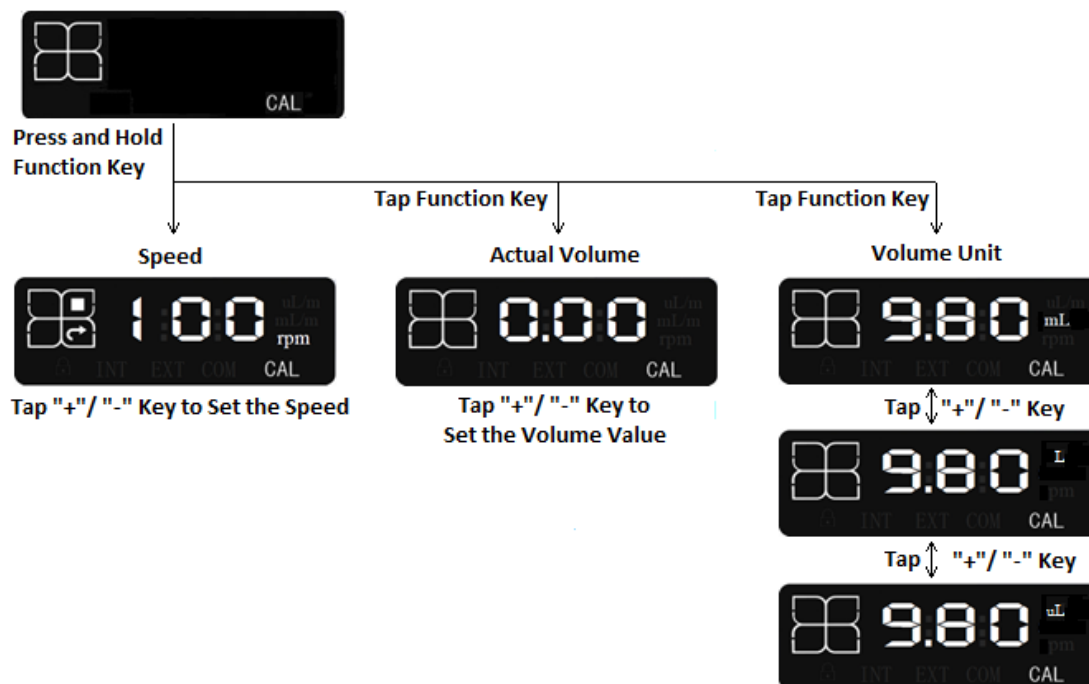

Flow rate calibration procedure:

1. Tap the Function Key  to highlight "CAL" . Press and

hold the Function Key to enter the flow rate calibration screen .

Then pump displays the speed same as the set speed in keypad control mode (or the equivalent speed if the pump has been configured to display the flow rate. Refer to Appendix 4 for the conversion relationship between flow rate and speed). Tap "+" or "-" key to set the speed for calibration, tap the Direction Key to set the running direction. **Note:** The speed and running direction set in the calibration screen will not change the speed and running direction in keypad control mode.

2. After setting the speed for calibration, tap the Start/Stop Key to run the pump. When a certain volume or required volume has been dispensed, tap the Start/Stop Key to stop the pump. Then pump will calculate the testing time automatically. If the testing time is too short, E02 error code will be displayed. Then tap the Function Key to return to the speed setting screen, and run the pump again. No E02 error code means a valid testing, then tap the Function Key to save the pump speed and the testing time, and enter the actual volume setting screen.

To avoid the E02 error code, please refer to the following requirements for the testing time:

- a. The testing time should be no less than 100 minutes, if the speed for calibration < 0.1rpm.
- b. The testing time should be no less than 10 minutes, if  $0.1\text{rpm} \leq \text{speed}$  for

calibration < 1rpm.

- c. The testing time should be no less than 1 minute, if  $1\text{rpm} \leq \text{speed}$  for calibration < 10rpm.
- d. The testing time should be no less than 6 seconds, if  $10\text{rpm} \leq \text{speed}$  for calibration.

To improve the efficiency of calibration, please select higher speed, and 100rpm is recommended.

To improve the flow rate accuracy, please extend the testing time as much as possible.



- 3. In the actual volume setting screen , the default value is 0.00. Tap “+” or “-” Key to set the actual pumped volume value during the testing time. Tap the Function Key to save the value and enter the volume unit setting screen.



- 4. In the volume unit setting screen , the default unit is mL. Tap “+” or “-” Key to set the volume unit corresponding to the volume value entered in previous step. The unit could be set as uL, mL or L. Tap the Function Key to save the setting, then the pump will calibrate the flow rate automatically and return to the calibration



function screen .

**Note:** If the actual dispensed volume within one minute corresponding to the calibration speed is known, calibration testing is not necessary. After setting the speed for calibration, do not run the pump, and tap the Function Key directly to save the speed, and enter the actual volume value setting screen. Then set the actual volume value within one minute corresponding to the speed set in previous step. Tap the Function Key to save the value and enter the volume unit setting screen. After setting the volume unit, tap the Function Key to calibrate the flow rate and return to the calibration function screen.

**Note:** If the calibrated flow rate exceeds the pump’s flow range, E04 error code will be displayed on the screen, which indicates the entered data in the calibration process is incorrect and the pump will not calibrate. Then tap the Function Key to return to the speed setting screen to re-enter the calibration parameters. Tap the Full Speed/Enter Key when E04 error code displayed on the screen if you wish to exit the calibration process and return to the calibration function screen. Then the calibration is invalid.

**Note:**

You could exit the calibration process by following below methods, and the calibration is invalid.

- a. In the speed setting screen, tap the Function Key continuously until E04 error code appears, then tap the Full Speed/ Enter Key to exit.

- b. In the actual volume setting screen, set the value as 0.00, then tap the Function Key continuously until E04 error code appears, and tap the Full Speed/Enter Key to exit.
- c. In the volume unit setting screen, tap the Full Speed/Enter Key to exit.



## 4.7 Reset to Factory Defaults

Switch the pump off. Press and hold the Function Key  on power up. Release the Function Key when enter the resetting factory defaults screen. Tap “+” or “-” key to switch

the display. When the screen displays , tap the Full Speed/Enter Key



to reset to factory defaults (refer to Appendix 4 for the defaults). When the screen

displays , tap the Full Speed/Enter Key , to maintain the user-set parameters and pump makes no change.

## 4.8 L100-1S-2 External Signal Control

### 4.8.1 Definition of External Control Port

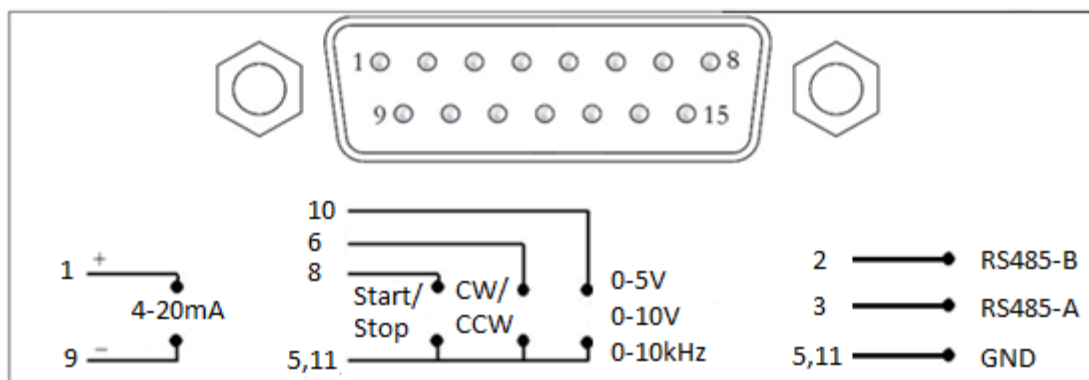

Pin 1: External speed control signal (4-20mA) input. Connected to 4-20mA signal +. The speed is in linear correlation with signal.

Pin 2: B of serial communication RS485. In the communication control mode, this pin is connected to B of RS485.

Pin 3: A of serial communication RS485. In the communication control mode, this pin is connected to the A of RS485.

Pin 5 and 11: COM for start/stop signal, running direction signal, 0-5V/0-10V/0-10KHz speed signal, and ground of RS485.

Pin 6: External running direction control input. The trigger mode of external running direction control can be set as level mode (momentary) or pulse mode (maintained). Control signal is switch signal.

Pin 8: External start/stop control input. The trigger mode of external start/stop control can be set as level mode (momentary) or pulse mode (maintained). Control signal is switch signal.

Pin 9: COM for the external speed control signal (4-20mA). Connected to 4-20mA signal -.

Pin 10: External speed control signal (0-5V, 0-10V or 0-10KHz) input. Connected to 0-5V, 0-10V or 0-10KHz signal +. The speed is in linear correlation with signal.

Pin 15: Connected to the shielded wire of external signal control cable. It is recommended that the external signal control cable has shielded wire, which should be connected to Pin 15.

Pin No.	Definition	Pin No.	Definition
1	4-20mA+	9	4-20mA-
2	RS485-B	10	Voltage Signal+ or Pulse Signal +
3	RS485-A	11	GND
4	Reserved	12	Reserved
5	GND	13	Reserved
6	Direction	14	Reserved
7	Reserved	15	PE, connected to the earth
8	Start/Stop		

#### 4.8.2 Steps for External Signal Control

Operating steps for external signal control:

1. Set the type of speed signal according to Chapter 4.5.2.1.
2. Set the max speed of external signal control according to Chapter 4.5.2.2. If the max speed needed is the default value of 100rpm, this step is not necessary.
3. Set the trigger mode of external start/stop control according to Chapter 4.5.2.3.
4. Set the trigger mode of external running direction control according to Chapter 4.5.2.4.
5. Power off the pump, and connect the control cable according to 4.8.1.
6. Power on the pump, and control the pump through external control signals.

**Note:**

1. Following parameters set in keypad control mode are still valid in external signal control mode: pump displays speed or flow rate, automatic keypad lock.
2. The pump stops when power on if the pump is working in the external signal control mode.
3. The control signal is valid only when the pump displays the running screen of external control mode.

## 4.9 L100-1S-2 Communication Control

L100-1S-2 could be controlled remotely by computer through serial communication with RS485 interface. And the pump is compatible with both Longer protocol and Modbus RTU protocol, which could be identified automatically. The pump stops when power on if the pump is working in the communication control mode.

### 4.9.1 Communication Control Using Longer OEM Protocol

Using the Longer OEM protocol, the pump address could be set as 1-30. Please refer to Appendix 1 for the protocol detail. The pump control mode needs to be set as communication control “COM”. The communication parameters could be set through the keypad (refer to Chapter 4.5.3 for details), or through the command (refer to Appendix 4 for the parameter defaults).

**Note:**

1. Following parameters set in keypad control mode are still valid in external signal control mode: pump displays speed or flow rate, automatic keypad lock.
2. The command is valid only when pump displays the running screen of communication control mode.

### 4.9.2 Communication Control Using Modbus RTU Protocol

Using the Modbus RTU protocol, the pump address could be set as 1-32. Please refer to Appendix 2 for the register map. The pump control mode needs to be set as communication control “COM”. The communication parameters could be set through the keypad (refer to Chapter 4.5.3 for details), or through the command (refer to Appendix 4 for the parameter defaults).

**Note:**

1. Following parameters set in keypad control mode are still valid in external signal control mode: pump display speed or flow rate, automatic keypad lock.
2. The command is valid only when pump displays the running screen of communication control mode.

## Appendix 1 Longer OEM Protocol

1. Frame format: 1start + 8data + parity + stop bit ,  
 Baud rate: 1,200bps, 2,400bps, 4,800bps, 9,600bps, 19,200bps or 38,400bps  
 Parity: no parity, odd parity or even parity  
 Stop bit: 1 stop bit, or 2 stop bits.  
 The parameters in command need to be the same as the parameters of the pump.
2. Message format: flag+ addr + len + pdu + fcs。
  - flag: E9H, the message head. When sending the message, the data E8H after message head will be replaced with E8H 00H, and E9H after message head will be replaced with E8H 01H. When receiving the message, the data E8H 00H after message head will be reverted to E8H, and E8H 01H after message head will be reverted to E9H. (Note: if E8 00 replaced E8 or E8 01 replaced E9, E8 00 or E8 01 will be regarded as one byte, no influence on the length of **pdu**.)
  - addr: one byte, pump address, 1-30.
  - len: one byte, length of **pdu**.
  - fcs: one byte, XOR of **addr, len , pdu**.
3. **pdu** format: application layer code data content

### 3.1 PC sets pump's running parameter (speed)

PC sends command:

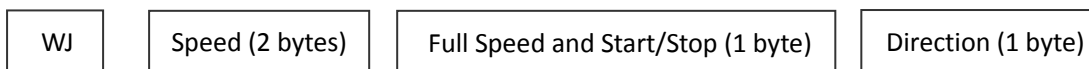

Pump responses:

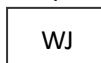

- WJ: 2 bytes, using ASCII code, to indicate that this command is used to set pump's running parameter (speed). ASCII code of W is 57H, ASCII code of J is 4AH
- Speed: 2 bytes, in increments of 0.01 rpm, hexadecimal number, most significant byte first. Example: 1770H means 60.00rpm.
- Full speed and start/stop:
  - Bit0: 1 means pump runs, 0 means pump stops.
  - Bit1: 1 means full speed, 0 means normal speed.
- Direction:
  - Bit0: 1 means CW, 0 means CCW.

**Note:** the pump will display speed after receiving this command.

### 3.2 PC reads pump's running state (speed)

PC calls:

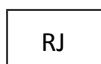



Pump responses:

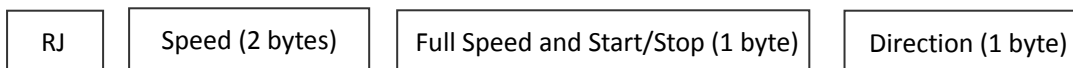

- RJ: 2 bytes, using ASCII code, to indicate that this call is used to read pump's running state. ASCII code of R is 52H, ASCII code of J is 4AH.
- Refer to para. 3.1 for instructions of speed, full speed, start/stop, direction

### 3.3 PC sets the pump communication parameters

PC sends command:

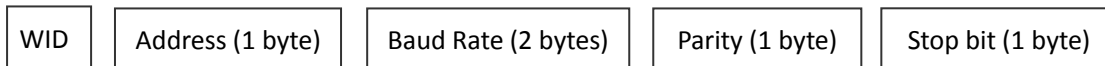

Pump Responses:

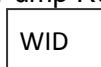

- WID: 3 bytes, using ASCII code, to indicate that this command is used to set the communication parameters. ASCII code of W is 57H. ASCII code of I is 49H. ASCII code of D is 44H.
- Pump address: 1 byte, valid range: 1-30.
- Baud rate: 2 bytes. High byte is 00H, low byte setting as below table.

Low Byte	Baud Rate (bps)
01H	1200
02H	2400
03H	4800
04H	9600
05H	19200
06H	38400
Other value	Invalid

- Parity: 1 byte, setting as below table.

Setting	Parity
01H	No Parity
02H	Odd Parity
03H	Even Parity
Other value	Invalid

- Stop Bit: 1 byte, setting as below table.

Setting	Stop Bit
01H	1 stop bit
02H	2 stop bits
Other value	Invalid

### 3.4 PC sets pump's running parameter (flow rate)

PC sends command:

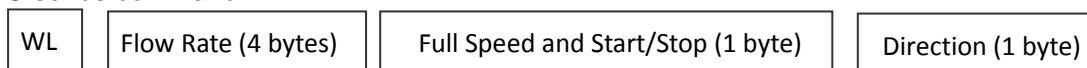

Pump responses:

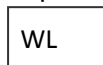

- WL: 2 bytes, using ASCII code, to indicate that this command is used to set the pump running parameter (flow rate). ASCII code of W is 57H. ASCII code of L is 4CH.
- Flow rate: 4 bytes, hexadecimal number, most significant byte first. The unit of flow rate is 1nL/min. Example: 02 FA F0 80H means 50.0mL/min.
- Full speed, start/stop, direction: refer to para. 3.1 for setting.

**Note:** the pump will display flow rate after receiving this command.

### 3.5 PC reads pump's running state (flow rate)

PC calls:

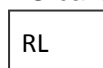

Pump responses:

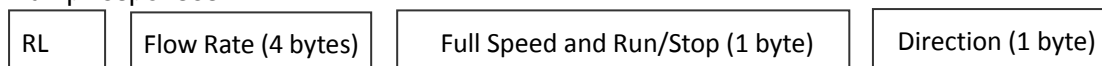

- RL: 2 bytes, using ASCII code to indicate that this call is used to read pump's running state. ASCII code of R is 52H, ASCII code of L is 4CH.
- Flow rate: 4 bytes, hexadecimal number, most significant byte first. The unit of flow rate is 1nL/min. Example: 02 FA F0 80H means 50.0mL/min.
- Full speed, start/stop, direction: refer to para. 3.1 for setting.

Example:

Set L100-1S-2 (Address: 1) to run CCW at speed of 50.0 rpm. The message is:

E9 01 06 57 4A 13 88 01 01 81

## Appendix 2 Modbus RTU Protocol

Parameter	Address	Data Type	Note
<b>Speed</b>	0x01	uint_16	Range: 1-10000, corresponding to 0.01rpm to 100rpm, in increments of 0.01rpm, pump displays speed with unit of rpm. Example: 100 means 0.01rpm. 10000 means 100rpm.
<b>Flow Rate</b>	0x02	uint_16	The high bytes of the flow rate Used in conjunction with the low byte of flow rate. The unit of flow rate is 1nL/min. Example: 02 FA F0 80H means 50.0mL/min.
	0x03	uint_16	The low bytes of the flow rate Used in conjunction with the high byte of flow rate. The unit of flow rate is 1nL/min. Example: 02 FA F0 80H means 50.0mL/min.
<b>Pump State</b>	0x04	uint_16	Low byte is valid. BIT0:run/stop      0: stop; 1: run BIT1:full speed    0: normal speed; 1: full speed BIT2: display speed or flow rate    0: speed; 1: flow rate BIT3: reserved BIT4: running direction      0: CW 1: CCW
<b>Pump Address</b>	0x05	uint_16	Low byte is valid. Range:1-32
<b>Baud Rate</b>	0x06	uint_16	Low byte is valid. 01H: 1200bps; 02H: 2400bps; 03H: 4800bps; 04H: 9600bps; 05H: 19200bps; 06H: 38400bps
<b>Parity</b>	0x07	uint_16	Low byte is valid. 01H: no parity; 02H: odd parity; 03H: even parity;
<b>Stop Bit</b>	0x08	uint_16	Low byte is valid. 01H: 1 stop bit 02H: 2 stop bits
<b>Keypad Lock</b>	0x09	uint_16	Low byte: to enable the keypad lock function. 01H: keypad lock function is disabled. 02H: keypad lock function is enabled. High byte: the delay time between the beginning idle and locking 00H: 30s 01H: 60s 02H: 180s 03H: 300s 04H: 480s 05H: 600s

**Note:**

1. When set flow rate, the high bytes and low bytes need to be set at the same time. The unit of flow rate is 1nL/min. Example: 02 FA F0 80H means 50.0mL/min.
2. When the set flow rate or speed is out of range, there is no warning, and the pump only displays the maximum or minimum value.
3. The communication parameters (address, baud rate, parity, stop bit) will be effective immediately after pump receives the commands. If pump receives invalid parameters, will ignore it.
4. Longer Modbus RTU protocol only support function codes of 03H (read registers), 06H (preset single register) and 10H (preset multiple registers).
5. When use the function code of 10H, and write registers of 0x01, 0x02 and 0x03 at the same time, the pump will display pump speed.
6. When use the function code of 06H, the pump will operate according to the last command. The pump will display the pump speed when receives speed parameter, and will display the flow rate when receives flow rate parameter.













---



### Appendix 3 Error code

In case of an operating error of the peristaltic pump, the error code will be displayed on the LCD, as follows:

Error Code	Description	Remark
<b>E01</b>	Communication failure between CPU of the mainboard and the external signal control board.	Contact Longer after sales service
<b>E02</b>	Flow rate calibration testing time is too short	Contact Longer after sales service
<b>E03</b>	Flow rate unit is not correct.	Check the parameter setting.
<b>E04</b>	Flow rate is out of range.	Check the parameter setting.
<b>E05</b>	Read or write parameters incorrectly.	Reset to the factory defaults. Contact Longer after sales service if E05 still appears on the screen.

### Appendix 4 Factory Defaults

Control Mode	Screen	Factory Defaults
INT	Running Screen	
	Set display flow rate or speed	
	Set pump state when power on	
	Set automatic keypad lock	
	Set timing work mode	
EXT	Running Screen	
	Set the speed signal type	
	Set the max speed	
	Set the trigger mode of start/stop control	
	Set the trigger mode of direction control	
COM	Running Screen	
	Set the pump address	
	Set the baud rate	

Control Mode	Screen	Factory Defaults
COM	Set the parity	
	Set the stop bit	

### Appendix 5 Conversion Relationship Between Flow Rate and Speed

$$L = R * k$$

L: Flow rate, dimension: mL/min

R: Speed, dimension: r/min, rpm

K: Flow rate coefficient, dimension: mL/r

The factory default of K is 1.